



FISHING  
TACKLE



CATALOGUE  
2024



G.CARP



**G.CARP**

# GOLDEN CATCH

RODS .....	6	FLOATS .....	75	KEEPNETS .....	104
REELS .....	34	FLOAT RIGS .....	79	<b>SINTEZ</b> SERIES .....	105
BRAIDED LINES .....	43	BOMBARD FLOATS .....	79	BOXES .....	108
FLUOROCARBON .....	45	SNAPS .....	80	LEADER KEEPERS / BAGS / BUCKETS /	
NYLON LINES .....	46	SWIVELS .....	82	BACKPACKS / VEST / TUBE .....	110
SPINNERS .....	49	RIG ACCESSORIES .....	84	CAMPING FURNITURE .....	115
SPOONS .....	50	CATFISH ACCESSORIES .....	85	TENTS .....	119
SPINNERBAITS .....	58	FEEDER ACCESSORIES /		UMBRELLAS .....	121
METAL JIGS .....	59	CARP ACCESSORIES .....	87	VACUUM FLASKS .....	121
ICE JIGS .....	62	BITE ALARMS .....	94	ACCESSORIES .....	122
READY RIGS .....	62	ROD HOLDERS / ROD PODS .....	97	SUNGLASSES .....	124
SABIKI .....	63	LANDING NETS .....	98	GUIDES / TIP GUIDES .....	126
HOOKS .....	65	LANDING NET HANDLES .....	101	CLOTHING .....	128
TUNGSTEN SINKERS .....	74	LANDING NET HEADS .....	102	<b>G.CARP</b> SERIES .....	132



RODS .....	150	TUNGSTEN SINKERS / STOPPERS /		KEEPNETS .....	188
REELS .....	158	CONNECTORS .....	177	BACKPACKS .....	190
BRAIDED LINES .....	164	SNAPS / SWIVELS /		COVERS .....	190
NYLON LINES .....	165	READY RIG ACCESSORIES .....	178	BOXES .....	193
SPOON .....	169	LEADERS .....	179	BUCKETS .....	193
SILICONE .....	170	BITE ALARMS .....	180	ACCESSORIES .....	195
HOOKS .....	174	ROD HOLDERS / ROD PODS .....	181	GUIDES / TIP GUIDES .....	197
SEA READY RIGS .....	176	LANDING NETS .....	182	CLOTHING .....	198

# GET YOUR BEST CATCH





Golden Catch brand has been present on the fishing market for over 20 years. High-quality products and attention to details will not leave any angler indifferent.

The product assortment has everything that a modern fisherman may need – from hooks, reels, rods to sleeping bags, umbrellas and tents. Each product was tested under different conditions and finalized taking into account the latest trends and the needs of anglers.

Best value for money and thoughtful design is why anglers choose Golden Catch.



**NEW**

**MIRROX**



**MIRROX** – updated series of spinning rods from the GOLD-EN CATCH brand.

The wide range of models covers almost all possible fishing conditions, which allows everyone to choose the right model, and specially designed blanks will satisfy even the most demanding anglers.

The geometry of the blanks is designed in such a way that it successfully combines excellent casting characteristics, high power and sensitivity.

The blanks confidently show top touching the bottom in muddy areas due to the action, and on hard bottom and during retrieve they provide high tactility due to high-quality carbon with a modulus of 30T.

High-quality Weibo components and ergonomic EVA handles, the length of which is calculated individually for each model, complete the picture.

- Blanks modulus 30T
- High sensitivity
- High-quality Weibo components
- Ergonomic EVA handle
- Stylish design.



code	model	length, m	pcs	folded, cm	weight, g	casting, g	power	action	recommended #PE
2039700	MRS-662ML	1.98	2	104	115	4-18	ML	fast	0.5-1.0
2039703	MRS-702M	2.13	2	112	130	6-25	M	fast	0.6-1.2
2039705	MRS-702MH	2.13	2	112	135	10-38	MH	fast	0.8-1.5
2039704	MRS-702MMH	2.13	2	112	140	7-28	MMH	fast	1.0-2.0
2039709	MRS-762H	2.29	2	121	162	15-60	H	fast	1.2-2.5
2039714	MRS-802M	2.44	2	128	133	6-25	M	fast	0.5-1.0
2039713	MRS-802ML	2.44	2	128	137	4-21	ML	fast	0.8-1.5
2039715	MRS-822M	2.49	2	130	143	7-28	M	fast	0.8-1.5
2039717	MRS-822H	2.49	2	130	176	15-65	H	fast	1.2-2.5
2039718	MRS-822XH	2.49	2	130	182	20-90	XH	moderate-fast	1.5-3.5
2039719	MRS-862M	2.59	2	135	150	7-28	M	fast	0.8-1.5

- material – graphite
- type of tip – tubular

**INQUISITOR MONSTER EDITION**

**INQUISITOR MONSTER EDITION** – series of powerful and super powerful rods from the GOLDEN CATCH brand. Designed specifically for catching trophy fish with large and extra-large lures. Each model has special properties and reveals itself to the fullest in its element. The rods are made of high quality 40T carbon and equipped with high-quality Weibo components. The guides with SiC inserts have a high surface finish, which ensures minimal friction and extends the life of the braided lines.

code	model	length, m	pcs	folded, cm	weight, g	casting, g	power	action	recommended #PE
2039425	INC-832SXH	2.51	2	130	166	30-120	SXH	moderate-fast	1.5-4.0
2039426	INS-792H	2.36	2	123	132	14-56	H	fast	1.2-2.5
2039427	INS-802XH	2.44	2	126	153	18-70	XH	fast	1.2-3.0
2039428	INS-862SXH	2.59	2	133	168	25-100	SXH	moderate-fast	1.5-3.5

- material – graphite
- type of tip – tubular



**Inquisitor Monster Edition INC-832SXH** – the most powerful model in the series. When choosing the appropriate reel, you can use the most resistant and large baits. The medium-fast action ensures the most comfortable casting of various types of lures, and the high stiffness of the blank allows you to make animations of any complexity.

**Inquisitor Monster Edition INS-792H** and **Inquisitor Monster Edition INS-802XH** are designed primarily for jiggling in places with great depths and strong currents. Also suitable for fishing on large unloaded silicone and large spoons.

**Inquisitor Monster Edition INS-862SXH** – the longest model in the series, and the second most powerful in the line. Intended for fishing with large moving baits – jerks, bucktails, wobblers, large and extra large spoons and spinners. Can also be used for fishing on unloaded silicone and for heavy jiggling.

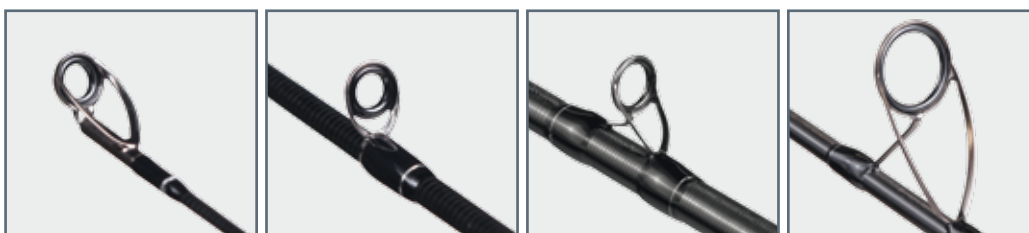

**SCAN ME**

### INQUISITOR TRAVEL

code	model	length, m	pcs	folded, cm	weight, g	casting, g	power	action
2039400	INS-764ML	2.29	4	63	125	4-18	ML	fast
2039401	INS-764MH	2.29	4	62.5	147	8-32	MH	fast
2039402	INS-794H	2.36	4	64	159	10-42	H	fast

- material – graphite
- type of tip – tubular



### INQUISITOR

code	model	length, m	pcs	folded, cm	weight, g	casting, g	power	action
2039300	INS-662M	1.98	2	103	110	5-21	M	fast
2039301	INS-662MH	1.98	2	103	120	8-32	MH	fast
2039315	INC-662MH	1.98	2	103	120	8-32	MH	fast
2039311	INS-692MH	2.06	2	107	127	10-35	MH	fast
2039312	INS-732M	2.21	2	114	125	6-24	M	fast
2039313	INS-762L	2.29	2	119	116	2-12	L	fast
2039302	INS-762ML	2.29	2	118.5	125	4-18	ML	fast
2039303	INS-762MH	2.29	2	119	133	7-32	MH	fast
2039314	INS-802ML	2.44	2	127	121	3-15	ML	fast
2039304	INS-802M	2.44	2	127	130	7-28	M	fast
2039305	INS-802H	2.44	2	127	138	10-42	H	fast
2039306	INS-832M	2.51	2	130	131	6-24	M	fast
2039307	INS-842ML	2.54	2	131	129	4-16	ML	fast
2039309	INS-862ML	2.59	2	134	135	5-21	ML	fast
2039308	INS-862MH	2.59	2	134	134	7-28	MH	fast
2039310	INS-962H	2.89	2	150	185	14-56	H	regular-fast

- material – graphite
- type of tip – tubular

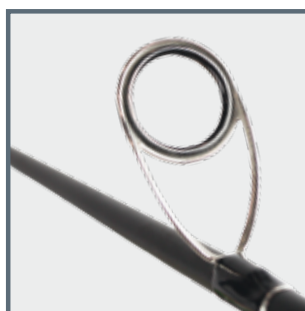
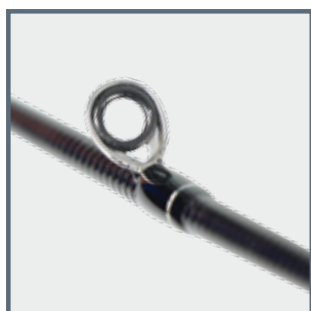
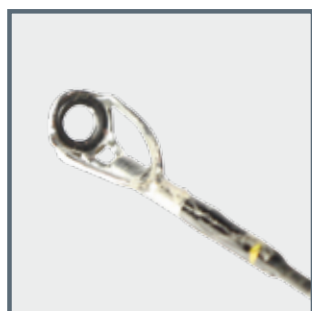

SCAN ME



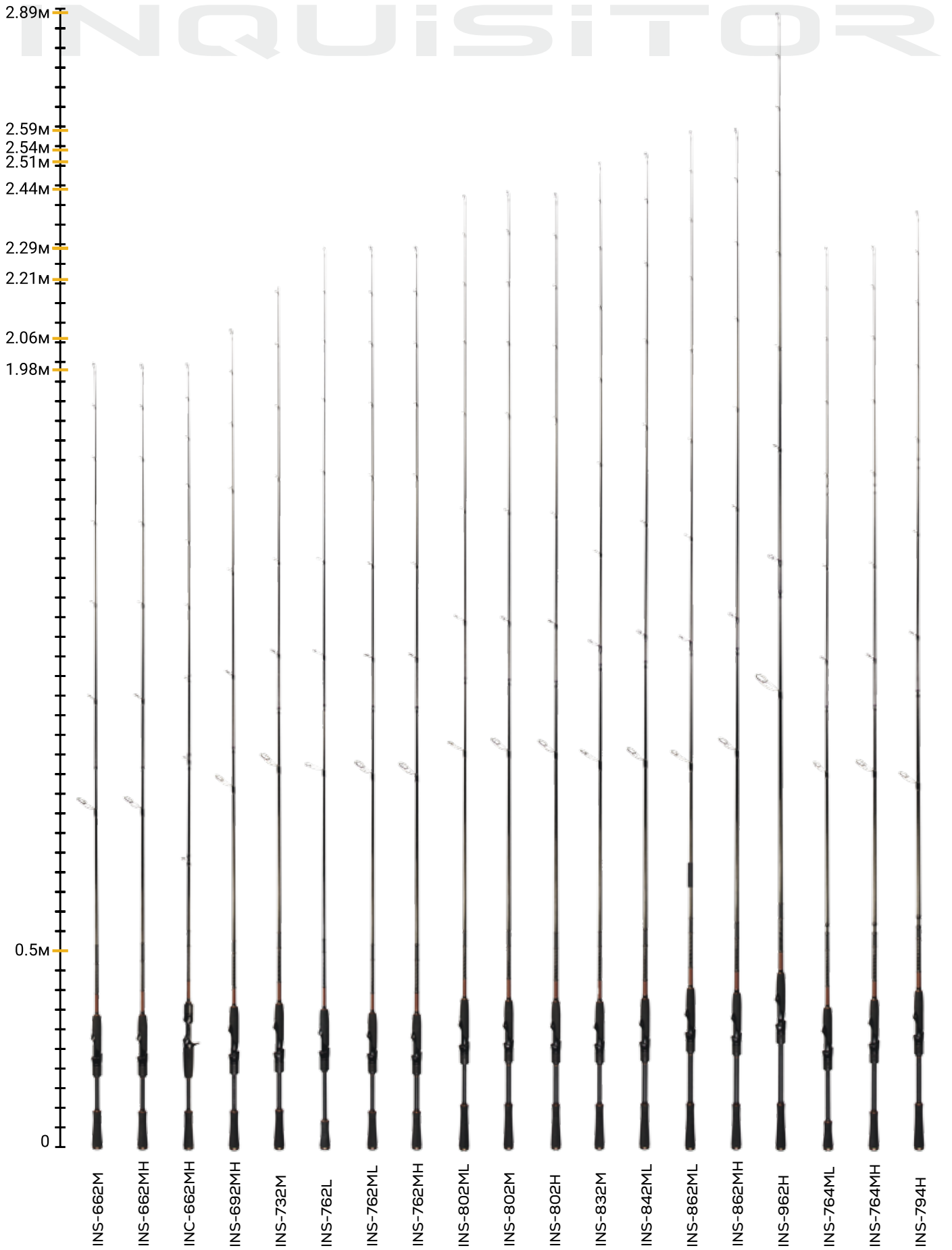

**BLACK JERK**

If you are going to fish in shallow water with jerk baits, big silicone baits and other baits, which sizes amaze people around. If your target big pike – Black Jerk is what you need!

Blank made of mixed carbon 24T and 30T, which makes it reliable and powerful as much as possible. It allows the rod to handle colossal loads during fighting with big trophy.

“Wobbler” action of the rod allows you to make comfortable casting of big baits and also greatly tires fish during reeling in.

Stylish handle with anti-slip rubber coating, besides good looking, provides secure grip, which is important during fighting with a trophy.

The rod is equipped with Sea Guide Sic guides with LS inner rings. Such type of inner ring has the cleanest surface, which excludes chances of braided/nylon lines pre-wear under heavy loads.

In addition to its intended purpose, Black Jerk works greatly with big and extra-big spinnerbaits, wobbler minnows with sizes 160+ and spoons.

- Blank made of mixed carbon 24T and 30T
- Ergonomic handle with anti-slip rubber coating
- Sea Guide SIC guides with LS inner rings
- High power
- Great work with big baits during casting or retrieving

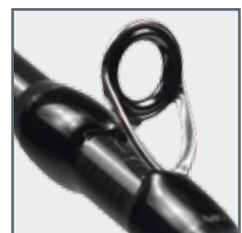
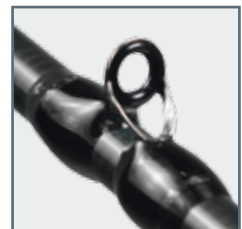
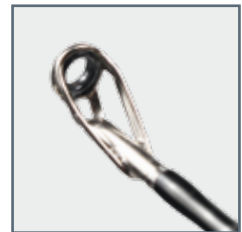

**Black Jerk**

**BIG BAIT ROD**



code	model	length, m	pcs	folded, cm	weight, g	casting, g	power	action
2039440	BJC-602XH	1.80	2	95		40-140	XH	fast

- material – graphite
- type of tip – tubular

**ENDORFIN**

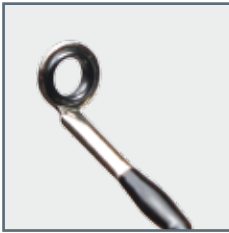

SCAN ME

ENDORFIN – hormone of fishing happiness, which is embodied in the top-class spinning rod from Golden Catch. Spinning rod series ENDORFIN was created exclusively for positive emotions not only from the process of fishing, but also from the possession of gear of such level.

The blank is made of carbon mix 40T and 46T to achieve exceptional performance and combine lightness, strength, stiffness, sensitivity and incredible casting performance in one rod. And to emphasize all the properties of the blank, the rods are equipped with Fuji rings in titanium frame with TORZITE inner rings.

- Blank made of mixed carbon 40T and 46T
- All components – Fuji
- Fuji TORZITE titanium guides
- Ergonomic, stylish EVA handle
- High sensitivity
- Elegance in every centimeter



code	model	length, m	pcs	folded, cm	weight, g	casting, g	power	action
2039610	EDS-610UL-S	2.08	2	107	79	0.2-4	UL	fast
2039611	EDS-74L-S	2.24	2	115	89	0.9-10	L	fast
2039612	EDS-84ML-S	2.54	2	130	99	2-14	ML	fast

- material – graphite
- type of tip – solid

### ATTREZZO

Series of professional, incredibly stylish, light rods from Golden Catch.

The blanks are made by a complex combination of graphite 30T, 36T and 40T, which made it possible to achieve enormous strength characteristics while maintaining the highest sensitivity. ATTREZZO is built with Fuji components and equipped with guides with SiC-S inner rings.

- Blank made of mixed carbon 30T, 36T and 40T
- All components – Fuji
- Guides with Sic inner rings
- Ergonomic, stylish EVA handle
- High sensitivity
- Excellent casting performance



SCAN ME



code	model	length, m	pcs	folded, cm	weight, g	casting, g	power	action
2039600	710LT	2.39	2	122	99	0.9-12	L	fast
2039601	710MLT	2.39	2	122	108	1.5-18	ML	fast
2039602	83LT	2.51	2	129	103	0.9-10	L	fast
2039603	83MLT	2.51	2	129	107	1.2-16	ML	fast
2039604	90MLT	2.74	2	141	116	1.5-16	ML	regular-fast

- material – graphite
- type of tip – tubular



### VERTAIS

code	model	length, m	pcs	folded, cm	weight, g	casting, g	power	action
2039209	VRS-732ULT	2.21	2	116	91	1.5-8	UL	fast
2039210	VRS-762LT	2.29	2	119	98	3-12	L	fast
2039213	VRS-762MLT	2.29	2	119	106	4-18	ML	fast
2039214	VRS-792ULT	2.36	2	124	109	1.5-8	UL	fast
2039211	VRS-7102LT	2.39	2	125	106	3-12	L	fast
2039212	VRS-842LT	2.54	2	133	121	4-18	L	fast

- material – graphite
- type of tip – tubular

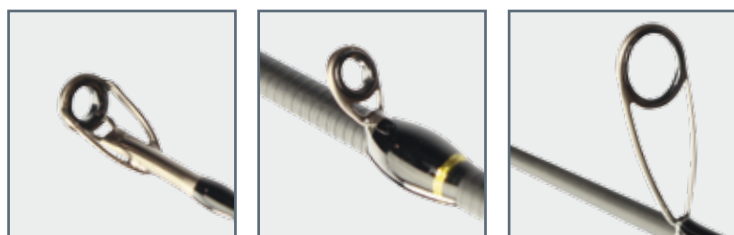

### VOLT

code	model	length, m	pcs	folded, cm	weight, g	casting, g	power	action
2039240	VLS-662ULT	1.98	2	104	90	1.2-5	UL	regular-fast
2039241	VLS-682ULT	2.03	2	107	94	1.5-6	UL	regular-fast
2039242	VLS-732ULT	2.21	2	115	98	2-10	UL	regular-fast
2039243	VLS-742LT	2.24	2	116	103	2-12	L	fast

- material – graphite
- type of tip – tubular

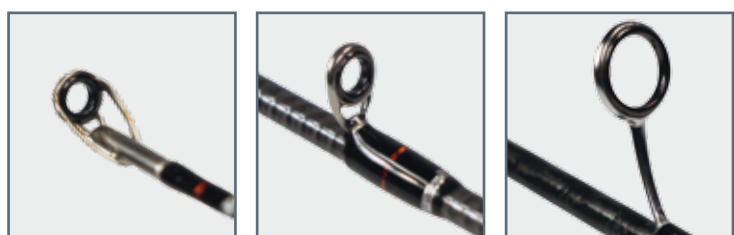

SCAN ME

**TRAISE**

code	model	length, m	pcs	folded, cm	weight, g	casting, g	power	action
2039204	TRS-732ULS	2.21	2	116	91	1.5-10	UL	fast
2039205	TRS-762LS	2.29	2	118	101	2-15	L	fast
2039206	TRS-7102LS	2.39	2	125	100	2-12	L	fast
2039207	TRS-842LS	2.54	2	131	102	2-12	L	fast

- material – graphite
- type of tip – solid



**WANDERER**

code	model	length, m	pcs	folded, cm	weight, g	casting, g	power	action
2039230	WRS-705ULS	2.13	5	53	108	0.9-8	UL	extra-fast
2039231	WRS-765LS	2.29	5	56	113	2-12	L	fast

- material – graphite
- type of tip – solid
- tube includedd



### FLICK

code	model	length, m	pcs	folded, cm	weight, g	casting, g	power	action
2039199	FLS-682ULS	2.03	2	107	76	0.3-4	UL	extra-fast
2039200	FLS-702ULS	2.13	2	111	80	0.5-6	UL	extra-fast
2039201	FLS-732ULS	2.21	2	114	86	0.6-7	UL	extra-fast
2039202	FLS-762ULS	2.29	2	118	98	0.8-8	UL	fast

- material - graphite
- type of tip - solid

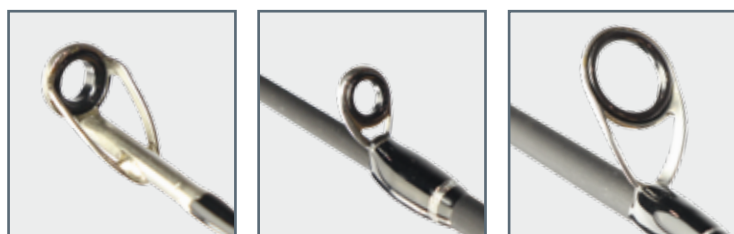

### DESIRE

code	model	length, m	pcs	folded, cm	weight, g	casting, g	power	action
2039227	DSS-662ML	1.98	2	103	121	5-17	ML	fast
2039225	DSS-662M	1.98	2	104	123	5-21	M	fast
2039226	DSS-662MH	1.98	2	104	135	7-28	MH	regular-fast
2039228	DSS-662H	1.98	2	118	90	10-35	MH	fast

- material - graphite
- type of tip - tubular

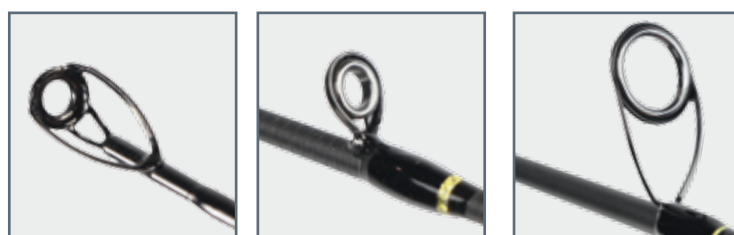



**VITTOR**

code	model	length, m	pcs	folded, cm	weight, g	casting, g	power	action
2039395	VTS-662MML	1.98	2	104	125	5-21	MML	moderate-fast
2039396	VTS-662M	1.98	2	104	130	6-24	M	moderate-fast
2039397	VTS-662MH	1.98	2	104	135	10-35	MH	moderate-fast
2039391	VTS-762M	2.29	2	119	125	4-20	M	fast
2039216	VTS-802MS*	2.44	2	126	143	4-22	M	extra-fast
2039215	VTS-802M	2.44	2	126	143	5-25	M	fast
2039392	VTS-802MH	2.44	2	127	155	7-32	MH	fast
2039217	VTS-902MH	2.74	2	141	170	8-35	MH	fast

- material – graphite
- type of tip – tubular
- \* type of tip – solid

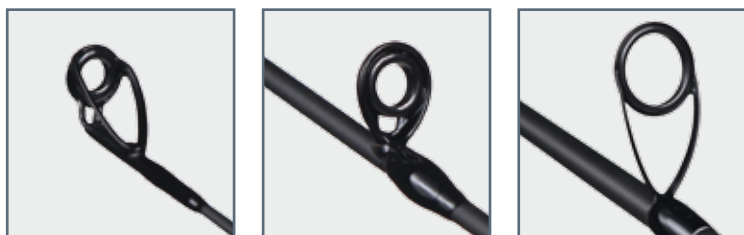

**SLASH**

code	model	length, m	pcs	folded, cm	weight, g	casting, g	power	action
2039222	SLS-662MML	1.98	2	104	125	5-21	MML	regular-fast
2039220	SLS-662M	1.98	2	104	130	6-24	M	regular-fast
2039221	SLS-662MH	1.98	2	104	135	10-35	MH	regular-fast

- material – graphite
- type of tip – tubular



## NEW SPRINTER

code	model	length, m	pcs	folded, cm	weight, g	casting, g	power	action
2039155	NEW SPRINTER	2.10	2	108	132	3-15	L	fast
2039165	NEW SPRINTER	2.10	2	109	134	5-20	ML	fast
2039160	NEW SPRINTER	2.10	2	110	140	7-28	M	fast
2039156	NEW SPRINTER	2.40	2	125	148	3-15	L	fast
2039166	NEW SPRINTER	2.40	2	124	154	5-20	ML	fast
2039161	NEW SPRINTER	2.40	2	126	168	7-28	M	fast
2039162	NEW SPRINTER	2.70	2	142	192	7-28	M	fast

- material – graphite
- type of tip – tubular



## BRAID SPRINTER PE X4 LIME GREEN



P. 37

## REEL SPRINTER PE

**SINTEZ FEEDER**

code	model	length, m	pcs	folded, cm	weight, g	casting, g
2039020	SINTEZ FEEDER	2.70	2+3	143	150	up to 60
2039021	SINTEZ FEEDER	3.30	3+3	118	170	up to 90
2039022	SINTEZ FEEDER	3.60	3+3	127	215	up to 120
2039024	SINTEZ FEEDER	3.60	3+3	127	215	up to 150
2039023	SINTEZ FEEDER	3.90	3+3	137	230	up to 150

- material – graphite



SCAN ME



**QUIVER TIP SINTEZ FEEDER**

code	mm	color	OZ	casting, g	code	mm	color	OZ	casting, g
1739700	2.65	yellow	0.75	60	1739706	3.15	yellow	2	120
1739701	2.65	green	1	60	1739707	3.15	green	3	120
1739702	2.65	red	2	60	1739708	3.15	red	4	120
1739703	2.85	yellow	1	90	1739709	3.15	yellow	3	150
1739704	2.85	green	2	90	1739710	3.15	green	4	150
1739705	2.85	red	3	90	1739711	3.15	red	5	150

- material – graphite



### STELIOS ACTIVE FEEDER

code	model	length, m	pcs	folded, cm	weight, g	casting, g
2039260	STELIOS ACTIVE FEEDER	3.60	3+3	129	248	up to 90
2039265	STELIOS ACTIVE FEEDER	3.60	3+3	129	270	up to 120
2039261	STELIOS ACTIVE FEEDER	3.90	3+3	138	286	up to 90
2039266	STELIOS ACTIVE FEEDER	3.90	3+3	138	300	up to 120
2039267	STELIOS ACTIVE FEEDER	4.20	3+3	149	350	up to 160

- material – graphite



### STELIOS RIVER FEEDER

code	model	length, m	pcs	folded, cm	weight, g	casting, g
2039270	STELIOS RIVER FEEDER	3.60	3+3	129	208	up to 110
2039271	STELIOS RIVER FEEDER	3.90	3+3	138	249	up to 130

- material – graphite



### STELIOS COMPETITION FEEDER

code	model	length, m	pcs	folded, cm	weight, g	casting, g
2039275	STELIOS COMPETITION FEEDER	3.60	3+3	129	221	up to 75
2039276	STELIOS COMPETITION FEEDER	3.90	3+3	138	259	up to 90
2039277	STELIOS COMPETITION FEEDER	4.20	3+3	149	294	up to 90

- material – graphite



**QUIVER TIP STELIOS ACTIVE FEEDER**

code	mm	color	OZ	casting, g
1739770	2.25	yellow	1	90
1739771	2.25	green	2	90
1739772	2.25	red	3	90
1739777	2.25	yellow	2	120
1739778	2.25	green	3	120
1739773	2.25	red	4	120
1739774	2.25	yellow	3	160
1739775	2.25	green	4	160
1739776	2.25	red	5	160

- material – graphite



*STELIOS Active Feeder*

**QUIVER TIP STELIOS RIVER FEEDER**

code	mm	color	OZ	casting, g
1739780	2.65	yellow	2	110/130
1739781	2.65	green	3	110/130
1739782	2.65	red	4	110/130

- material – graphite

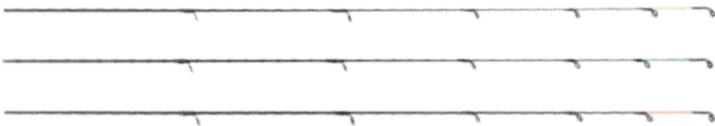

*STELIOS River Feeder*

**QUIVER TIP STELIOS COMPETITION FEEDER**

code	mm	color	OZ	casting, g
1739785	2.05	yellow	1	75
1739786	2.05	green	2	75
1739787	2.05	red	3	75
1739788	2.05	yellow	1	90
1739789	2.05	green	2	90
1739790	2.05	red	3	90

- material – graphite

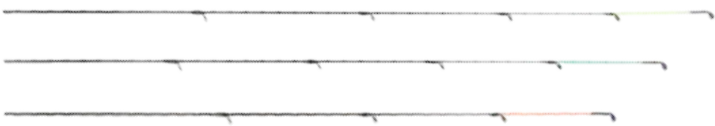

*STELIOS Competition Feeder*

### AIRONE FEEDER

code	model	length, m	pcs	folded, cm	weight, g	casting, g
2039290	AIRONE FEEDER	3.30	3+3	117	175	up to 40
2039291	AIRONE FEEDER	3.60	3+3	127	195	up to 60
2039292	AIRONE FEEDER	3.90	3+3	138	250	up to 90
2039293	AIRONE FEEDER	3.90	3+3	138	265	up to 120

- material - graphite



### QUIVER TIP AIRONE FEEDER

code	mm	color	OZ	casting, g	code	mm	color	OZ	casting, g
1739030	2.1	yellow	1	40/60	1739035	2.1	green	2	90
1739031	2.1	green	1.5	40/60	1739036	2.1	red	3	90
1739032	2.1	red	1.75	40/60	1739037	2.1	yellow	2	120
1739033	2.1	red	2	40	1739038	2.1	green	3	120
1739034	2.1	yellow	1.5	60	1739039	2.1	red	4	120

- material - graphite

### VERTE-X DISTANCE FEEDER

code	model	length, m	pcs	folded, cm	weight, g	casting, g
2039295	VERTE-X DISTANCE FEEDER	3.90	3+3	136	270	up to 100
2039296	VERTE-X DISTANCE FEEDER	4.20	3+3	146	310	up to 130
2039297	VERTE-X DISTANCE FEEDER	4.20	3+3	146	315	up to 160

- material - graphite



### QUIVER TIP VERTE-X DISTANCE FEEDER

code	mm	color	OZ	casting, g	code	mm	color	OZ	casting, g
1739745	3	yellow	1	100	1739750	3	red	4	130
1739746	3	green	2	100	1739751	3	yellow	3	160
1739747	3	red	3	100	1739752	3	green	4	160
1739748	3	yellow	2	130	1739753	3	red	5	160
1739749	3	green	3	130					

- material - graphite

**VERTE-X FEEDER**

code	model	length, m	pcs	folded, cm	weight, g	casting, g
2039183	VERTE-X FEEDER	3.60	3+3	127	206	up to 70
2039184	VERTE-X FEEDER	3.60	3+3	127	219	up to 90
2039185	VERTE-X FEEDER	3.60	3+3	127	235	up to 110
2039186	VERTE-X FEEDER	3.90	3+3	137	245	up to 130

- material – graphite



**QUIVER TIP VERTE-X FEEDER**

code	mm	color	OZ	casting, g	code	mm	color	OZ	casting, g
1739001**	2.7	yellow	1	70	1739012*	2.9	yellow	2	110
1739002*	2.7	green	2	70	1739013*	2.9	green	3	110
1739003*	2.7	red	3	70	1739014*	2.9	red	4	110
1739018**	2.7	yellow	1	90	1739015**	2.9	yellow	2	130
1739019*	2.7	green	2	90	1739016*	2.9	green	3	130
1739020*	2.7	red	3	90	1739017*	2.9	red	4	130

- material – graphite (\*)

- material – glass (\*\*)

**ONNEX RIVER FEEDER**

code	model	length, m	pcs	folded, cm	weight, g	casting, g
2039280	ONNEX RIVER FEEDER	3.60	3+3	129	298	up to 120
2039282	ONNEX RIVER FEEDER	3.60	3+3	129	292	up to 150
2039281	ONNEX RIVER FEEDER	3.90	3+3	138	320	up to 120
2039283	ONNEX RIVER FEEDER	3.90	3+3	138	334	up to 150
2039284	ONNEX RIVER FEEDER	3.90	3+3	138	367	up to 180

- material – graphite



**QUIVER TIP ONNEX RIVER FEEDER**

code	mm	color	OZ	casting, g	code	mm	color	OZ	casting, g
1739022**	3.1	yellow	1.5	120	1739025**	3.3	yellow	2	150
1739023**	3.1	green	2	120	1739026**	3.3	green	3	150
1739024*	3.1	red	3	120	1739027*	3.3	red	4	150

- material – graphite (\*)

- material – glass (\*\*)

### BIONIC FEEDER BLACK EDITION

code	model	length, m	pcs	folded, cm	weight, g	casting, g
2039245	BIONIC FEEDER BLACK EDITION 360M	3.60	3+3	129	260	up to 80
2039246	BIONIC FEEDER BLACK EDITION 360MH	3.60	3+3	129	274	up to 120
2039248	BIONIC FEEDER BLACK EDITION 360H	3.60	3+3	129	300	up to 150
2039255	BIONIC FEEDER BLACK EDITION 360XH	3.60	3+3	129	320	up to 200
2039247	BIONIC FEEDER BLACK EDITION 390MH	3.90	3+3	139	302	up to 120
2039249	BIONIC FEEDER BLACK EDITION 390H	3.90	3+3	139	315	up to 150
2039256	BIONIC FEEDER BLACK EDITION 390XH	3.90	3+3	139	334	up to 200
2039257	BIONIC FEEDER BLACK EDITION 420XH	4.20	3+3	149	367	up to 200

- material – graphite



### QUIVER TIP BIONIC FEEDER BLACK EDITION

code	mm	color	OZ	casting, g
1739720**	2.85	yellow	1	80
1739721*	2.85	green	2	80
1739722*	2.85	red	3	80
1739723**	2.85	yellow	2	120
1739724*	2.85	green	3	120
1739725*	2.85	red	4	120
1739726**	2.85	yellow	2	150
1739727*	2.85	green	3	150
1739728*	2.85	red	4	150
1739729**	2.85	yellow	3	150
1739730*	2.85	green	4	150
1739731*	2.85	red	5	150
1739732**	2.85	yellow	3	150
1739733*	2.85	green	4	150
1739734*	2.85	red	5	150
1739735**	2.85	yellow	4	200
1739736*	2.85	green	5	200
1739737*	2.85	red	6	200
1739738**	2.85	yellow	4	200
1739739*	2.85	green	5	200
1739740*	2.85	red	6	200
1739741**	2.85	yellow	4	200
1739742*	2.85	green	5	200
1739743*	2.85	red	6	200

- material – graphite (\*)
- material – glass (\*\*)



**BIONIC METHOD MULTI FEEDER**

code	model	length, m	pcs	folded, cm	weight, g	casting, g
2039500	BIONIC METHOD MULTI FEEDER	3.00/3.60	4+3	105	300	40-120
2039505	BIONIC METHOD MULTI FEEDER	3.00/3.60	4+3	105	310	60-160
2039501	BIONIC METHOD MULTI FEEDER	3.30/3.90	4+3	115	330	40-120
2039506	BIONIC METHOD MULTI FEEDER	3.30/3.90	4+3	115	335	60-160

- material – graphite



QUIVER TIP **BIONIC METHOD MULTI FEEDER**

code	mm	color	OZ	casting, g
1739760**	3.5	yellow	2	40-120
1739761**	3.5	green	3	40-120
1739762*	3.5	red	4	40-120

- material – graphite (\*)

code	mm	color	OZ	casting, g
1739763**	3.5	yellow	3	60-160
1739764*	3.5	green	4	60-160
1739765*	3.5	red	5	60-160

- material – glass (\*\*)

**BIONIC FEEDER**

code	model	length, m	pcs	folded, cm	weight, g	casting, g
2039180	BIONIC FEEDER	3.30	3+3	118	240	120
2039181	BIONIC FEEDER	3.60	3+3	129	265	120
2039175	BIONIC FEEDER	3.60	3+3	129	295	150
2039182	BIONIC FEEDER	3.90	3+3	138	275	120
2039176	BIONIC FEEDER	3.90	3+3	138	307	150
2039177	BIONIC FEEDER	4.20	3+3	150	338	180

- material – graphite



QUIVER TIP **BIONIC FEEDER**

code	mm	color	OZ	casting, g
1739004**	3	white	2	120
1739005**	3	yellow	3	120
1739006*	3	red	4	120

- material – graphite (\*)

code	mm	color	OZ	casting, g
1739007**	3	white	3	150/180
1739008*	3	yellow	4	150/180
1739009*	3	red	5	150/180

- material – glass (\*\*)

### SUPER STRONG & SUPER STRONG SPOD

code	model	length, m	pcs	folded, cm	weight, g	casting, lb
2039045	SUPER STRONG	3.60	3	128	311	3.5
2039046	SUPER STRONG	3.90	3	139	335	3.5
2039135	SUPER STRONG SPOD	3.60	3	128	475	5.5

- material – graphite



### X-3 CARP EVOLUTION SPOD

code	model	length, m	pcs	folded, cm	weight, g	casting, lb
2039130	X-3 CARP EVOLUTION SPOD	3.60	3	128	473	5.5

- material – graphite



### X-3 CARP EVOLUTION

code	model	length, m	pcs	folded, cm	weight, g	casting, lb
2039192	X-3 CARP EVOLUTION	3.30	3	118	368	3.5
2039190	X-3 CARP EVOLUTION	3.60	3	128	430	3.5
2039191	X-3 CARP EVOLUTION	3.90	3	137	525	3.5

- material – graphite



### TELE CARP EVOLUTION

code	model	length, m	pcs	folded, cm	weight, g	casting, lb
2039195	TELE CARP EVOLUTION	3.30	7	110	304	3.5
2039196	TELE CARP EVOLUTION	3.60	7	110	334	3.5
2039197	TELE CARP EVOLUTION	3.90	7	110	370	3.5

- material – graphite



**AMULLET SURF**

code	model	length, m	pcs	folded, cm	weight, g	casting, g
2039322	AMULLET SURF	4.20	3	146	535	100-220

- material – graphite



**AMULLET TELESURF**

code	model	length, m	pcs	folded, cm	weight, g	casting, g
2039320	AMULLET TELESURF	4.20	8	119	405	100-220

- material – graphite



**RIFT TRAVEL**

code	model	length, m	pcs	folded, cm	weight, g	casting, g	action
2039125	RIFT TRAVEL	2.10	5	55	667	500-2000	fast

- material – graphite



### GIMBAL FISH HOLDER

code

1665990

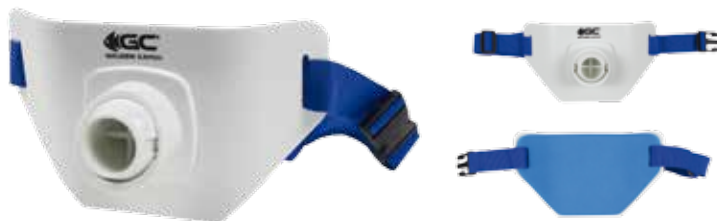

### ROCKY CATFISH

code	model	length, m	pcs	folded, cm	weight, g	casting, lb
2039365	ROCKY CATFISH	1.65	2	115	280	20
2039366	ROCKY CATFISH	1.65	2	115	285	30

- material - graphite

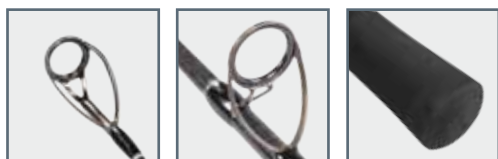

### SKYROS BOAT

code	model	length, m	pcs	folded, cm	weight, g	casting, g
2039370	SKYROS BOAT	1.80	2+2	97	106	60-120
2039371	SKYROS BOAT	2.10	2+2	106	120	60-120
2039372	SKYROS BOAT	2.40	3+2	111	156	60-120
2039373	SKYROS BOAT	2.70	4+2	115	195	60-120

- material - graphite



SCAN ME

## SKYROS

code	model	length, m	pcs	folded, cm	weight, g	casting, g
2539250	SKYROS	3.50	6	85	224	10-50

- material - graphite



## BOAT UNIVERSAL

code	model	length, m	pcs	folded, cm	weight, g	casting, g	action
2039040	BOAT UNIVERSAL	1.40-1.70	2+2	82	165	100-200	fast

- material - graphite



## PASSION BOAT TRAVEL

code	model	length, m	pcs	folded, cm	weight, g	casting, g
2039515	PASSION BOAT TRAVEL	2.13	4	59	165	20-60
2039516	PASSION BOAT TRAVEL	2.13	4	59	190	30-110
2039517	PASSION BOAT TRAVEL	2.13	4	59	215	40-160
2039518	PASSION BOAT TRAVEL	2.13	4	59	225	80-220

- material - graphite



### PASSION POWER TRAVEL

code	model	length, m	pcs	folded, cm	weight, g	casting, g	action
2039235	PASSION POWER TRAVEL	2.40	5	55	200	40-125	regular-fast
2039236	PASSION POWER TRAVEL	2.70	5	61	231	40-125	regular-fast
2039238	PASSION POWER TRAVEL	2.40	5	55	230	100-180	regular-fast
2039326	PASSION POWER TRAVEL	2.70	5	61	255	100-180	regular-fast
2039232	PASSION POWER TRAVEL*	2.40	5	55	230	100-180	regular-fast
2039233	PASSION POWER TRAVEL*	2.70	5	66	255	100-180	regular-fast

- material – graphite
- \* tube includedd



### PASSION POWER

code	model	length, m	pcs	folded, cm	weight, g	casting, g	action
2039150	PASSION POWER	2.40	2	127	220	100-180	regular-fast
2039140	PASSION POWER	2.40	2	127	190	40-125	regular-fast
2039151	PASSION POWER	2.70	2	143	252	100-180	regular-fast
2039141	PASSION POWER	2.70	2	143	210	40-125	regular-fast
2039152	PASSION POWER	3.00	2	155	276	100-180	regular-fast
2039142	PASSION POWER	3.00	2	155	225	40-125	regular-fast

- material – graphite



**ARMATUR TELE**

code	model	length, m	pcs	folded, cm	weight, g	casting, g
2039090	ARMATUR TELE	1.80	4	80	110	50-150
2039091	ARMATUR TELE	2.10	4	81	125	50-150
2039092	ARMATUR TELE	2.40	5	87	165	50-150
2039093	ARMATUR TELE	2.70	6	90	200	50-150
2039094	ARMATUR TELE	3.00	6	97	218	50-150
2039095	ARMATUR TELE	3.30	6	99	230	50-150

- material – graphite



**ARMATUR SPIN**

code	model	length, m	pcs	folded, cm	weight, g	casting, g	action
2039169	ARMATUR SPIN	2.10	2	110	180	100-250	extra-fast
2039170	ARMATUR SPIN	2.40	2	126	224	100-250	extra-fast
2039171	ARMATUR SPIN	2.70	2	142	278	100-250	extra-fast
2039172	ARMATUR SPIN	3.00	2	157	292	100-250	extra-fast

- material – composite/graphite



SCAN ME

### SINTEZ

code	model	length, m	pcs	folded, cm	weight, g
2500200	SINTEZ pole	5.00	5	143	107
2500201	SINTEZ pole	6.00	6	143	157
2500202	SINTEZ pole	7.00	7	143	228
2500203	SINTEZ pole	8.00	7	143	281



SCAN ME

- material – graphite





**HUNTER LEGEND**

code	model	length, m	pcs	folded, cm	weight, g	casting, g
2539210	HUNTER LEGEND bolo	4.00	4	114	145	max 30
2539211	HUNTER LEGEND bolo	5.00	5	115	210	max 30
2539212	HUNTER LEGEND bolo	6.00	6	116	310	max 30
2539215	HUNTER LEGEND pole	4.00	4	113	130	-
2539216	HUNTER LEGEND pole	5.00	5	113	170	-
2539217	HUNTER LEGEND pole	6.00	6	113	260	-

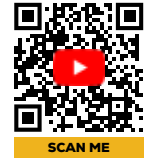

- material – graphite

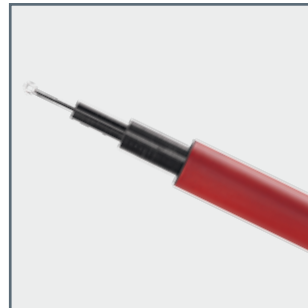

**EURO MASTER**

code	model	length, m	pcs	folded, cm	weight, g	casting, g
2539200	EURO MASTER bolo	4.00	4	119	154	max 25
2539201	EURO MASTER bolo	5.00	5	120	225	max 25
2539202	EURO MASTER bolo	6.00	6	120	325	max 25
2539205	EURO MASTER pole	4.00	4	116	122	-
2539206	EURO MASTER pole	5.00	5	116	188	-
2539207	EURO MASTER pole	6.00	6	116	264	-

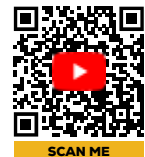

- material – graphite

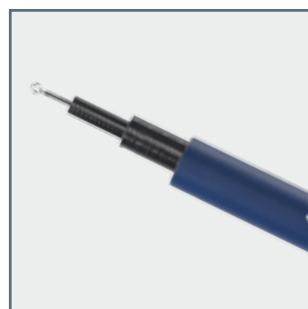

**NEW**

### VERTAIS

VERTAIS – new series of light reels in the GOLDEN CATCH product range.

They are designed specifically for the Vertais series of rods and have a common design with them. The rotor and body are made of carbon, which provides maximum weight reduction and increases the sensitivity of the tackle during fishing.

- AER CARBON – body and rotor made of carbon
- SRW HANDLE – screw-in handle
- Main gear made of aluminum and brass
- Line roller on two bearings
- Skeletal ergonomic carbon fiber knob, which increases sensitivity
- The oscillating slider has additional support in the form of metal shaft
- High-quality line laying
- Shallow spool optimized for braided lines
- 6+1 ball bearings
- 5.1:1 gear ratio.

**AER  
CARBON  
SRW  
HANDLE**



code	model	gear ratio	weight, g	max. drag power, kg	ball bearings	line capacity, mm-m	line capacity, #PE-m
1039040	2000S	5.1:1	205	5	6+1	0.165-120	0.5-150
1039041	2500S	5.1:1	225	8	6+1	0.185-120	0.6-150
1039042	3000S	5.1:1	235	8	6+1	0.205-120	0.8-150

**NEW**

### spool VERTAIS

code	model	line capacity, mm-m	line capacity, #PE-m
1739940	2000S	0.165-120	0.5-150
1739941	2500S	0.185-120	0.6-150
1739942	3000S	0.205-120	0.8-150



**VOLT**

**NEW**

VOLT – new series of the lightest reels in the GOLDEN CATCH product range.

They are designed specifically for the Volt series of rods and have a common design with them. The rotor and body are made of carbon, which provides maximum weight reduction and increases the sensitivity of the tackle during fishing.

- AER CARBON - body and rotor made of carbon
- SRW HANDLE - screw-in handle
- Main gear made of aluminum and brass
- Line roller on two bearings
- Skeletal ergonomic carbon fiber knob, which increases sensitivity
- The oscillating slider has additional support in the form of metal shaft
- High-quality line laying
- Shallow spool optimized for braided lines
- 6+1 ball bearings
- 5.1:1 gear ratio.

**AER  
CARBON  
SRW  
HANDLE**

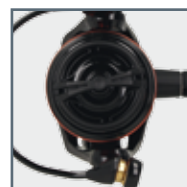
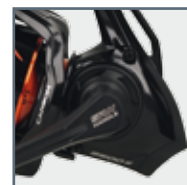

code	model	gear ratio	weight, g	max. drag power, kg	ball bearings	line capacity, mm-m	line capacity, #PE-m
1039045	1000S	5.1:1	200	5	6+1	0.148-130	0.4-150
1039046	2000S	5.1:1	205	5	6+1	0.165-120	0.5-150
1039047	2500S	5.1:1	225	8	6+1	0.185-120	0.6-150

**spool VOLT**

**NEW**

code	model	line capacity, mm-m	line capacity, #PE-m
1739945	1000S	0.148-130	0.4-150
1739946	2000S	0.165-120	0.5-150
1739947	2500S	0.185-120	0.6-150



## INQUISITOR



code	model	gear ratio	weight, g	max. drag power, kg	ball bearings	line capacity, mm-m / #PE-m
1039015	2500S	5.2	225	3	6+1	0.25-70 / 0.6-150
1039016	3000S	5.2	250	5	6+1	0.25-95 / 1.0-150
1039017	4000S	5.2	260	5	6+1	0.25-140 / 1.2-150

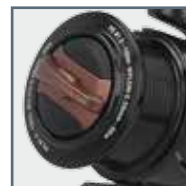

## spool INQUISITOR



code	model	line capacity, mm-m	line capacity, #PE-m
1739911	2500S	0.25-70	0.8-150
1739912	3000S	0.25-95	1.0-150
1739913	4000S	0.25-140	1.2-150

## MIRROX AIR



code	model	gear ratio	weight, g	max. drag power, kg	ball bearings	line capacity, mm-m	line capacity, #PE-m
1039002	3000S	5.2	250	8	6+1	0.25-140 / 0.30-100 / 0.35-70	1.5-150
1039003	4000S	5.2	260	8	6+1	0.25-200 / 0.30-145 / 0.35-105	2.0-150

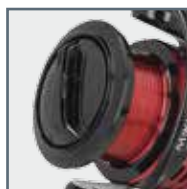

SCAN ME

**NEW**

## spool MIRROX AIR



code	model	line capacity, mm-m	line capacity, #PE-m
1739902	3000S	0.25-140 / 0.30-100 / 0.35-70	1.5-150
1739903	4000S	0.25-200 / 0.30-145 / 0.35-105	2.0-150

**MIRROX**



code	model	gear ratio	weight, g	max. drag power, kg	ball bearings	line capacity, mm-m/#PE-m
1039000	3000S	5.2	260	8	5+1	0.25-140 / 1.5-150
1039001	4000S	5.2	275	8	5+1	0.25-200 / 2.0-150



**spool MIRROX**



code	model	line capacity, mm-m	line capacity, #PE-m
1739900	3000S	0.25-140	1.5-150
1739901	4000S	0.25-200	2.0-150

**SPRINTER S-PE**



code	model	gear ratio	weight, g	max. drag power, kg	ball bearings	line capacity, mm-m/#PE-m
1039030	2000S-PE	5.2	235	4	6+1	0.23-100 / 0.8-150
1039031	3000S-PE	5.2	265	5	6+1	0.25-100 / 1.0-150
1039032	4000S-PE	5.2	285	5	6+1	0.32-100 / 1.5-150

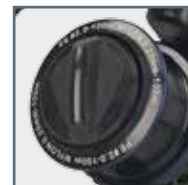

**spool SPRINTER S-PE**



code	model	line capacity, mm-m	line capacity, #PE-m
1739930	2000S-PE	0.23-100	0.8-150
1739931	3000S-PE	0.25-100	1.0-150
1739932	4000S-PE	0.32-100	1.5-150

**NEW**

## VERTE-X FEEDER



code	model	gear ratio	weight, g	max. drag power, kg	ball bearings	line capacity, mm-m
1039068	6000	5.0	380	12	6+1	0.26 - 120

**METAL BODY** – metal body

**XBS BEARING SYSTEMS** – main gear on 4 ball bearings

**ACR CARBON** – carbon rotor

**SRW HANDLE** – screw-in handle

# VERTE-X FEEDER 6000

## AIRONE



code	model	gear ratio	weight, g	max. drag power, kg	ball bearings	line capacity, mm-m
1039011	3000M	5.1	262	6	7+1	0.18-205 0.23-130 0.28-100
1039012	4000FD	5.5	362	8	7+1	0.23-170 0.28-130 0.33-80
1039010	6000FD	5.5	380	12	7+1	0.23-200 0.28-150 0.33-100

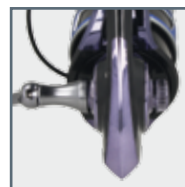

SCAN ME

## spool AIRONE



code	model	line capacity, mm-m
1739908	3000M	0.18-205 / 0.23-130 / 0.28-100
1739909	4000FD	0.23-170 / 0.28-130 / 0.33-80
1739910	6000FD	0.23-200 / 0.28-150 / 0.33-100

**ONNEX**



code	model	gear ratio	weight, g	max. drag power, kg	ball bearings	line capacity, mm-m
1039005	4000FD	5.5	360	8	5+1	0.24-165 0.28-120 0.30-105
1039006	5000FD	5.5	368	12	5+1	0.24-210 0.28-155 0.300-135
1039007	6000FD	5.5	400	12	5+1	0.28-170 0.30-150 0.35-110

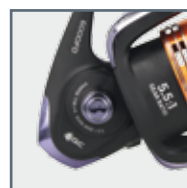
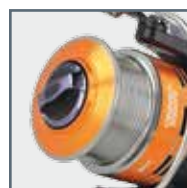

**spool ONNEX**



code	model	line capacity, mm-m
1739904	3000FD	0.18-175 / 0.22-120 / 0.24-100
1739905	4000FD	0.24-165 / 0.28-120 / 0.30-105
1739906	5000FD	0.24-210 / 0.28-155 / 0.30-135
1739907	6000FD	0.28-170 / 0.30-150 / 0.35-110

**PASSION POWER**



code	model	gear ratio	weight, g	max. drag power, kg	ball bearings	line capacity, mm-m
1039050	4000FD	5.2	356	5	5+1	0.30-150 0.35-110
1039051	5000FD	5.2	388	7	5+1	0.35-120 0.40-100
1039052	6000FD	5.2	392	7	5+1	0.40-120 0.45-100



SCAN ME

**spool PASSION POWER**

**NEW**



code	model	line capacity, mm-m
1739921	4000FD	0.30-150 / 0.35-110
1739922	5000FD	0.35-120 / 0.40-100
1739923	6000FD	0.40-120 / 0.45-100

**NEW**

### BIONIC LONG CAST



code	model	gear ratio	weight, g	max. drag power, kg	ball bearings	line capacity, mm-m
1039063	6000	4.7:1	465	12	6+1	0.30-270 / 0.35-195 / 0.40-150

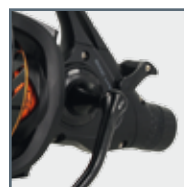

**NEW**

### spool BIONIC LONG CAST



code	model	line capacity, mm-m
1739936	10000	0.30-270 / 0.35-195 / 0.40-150

### BIONIC FEEDER



code	model	gear ratio	weight, g	max. drag power, kg	ball bearings	line capacity, mm-m
1039055	4000	5.0	289	5	4+1	0.25-120 / 0.28-100
1039056	5000	4.9	406	7	4+1	0.3-130 / 0.35-100
1039057	6000	4.9	422	7	4+1	0.35-118 / 0.40-100



### spool BIONIC FEEDER



code	model	line capacity, mm-m
1739925	4000	0.25-120 / 0.28-100
1739926	5000	0.3-130 / 0.35-100
1739927	6000	0.35-118 / 0.40-100



**SUPER STRONG**

**NEW**



code	model	gear ratio	weight, g	max. drag power, kg	ball bearings	line capacity, mm-m
1039065	10000	4.6:1	640	18	5+1	0.30-470 / 0.35-345 / 0.40-265



SCAN ME

**spool SUPER STRONG**

**NEW**



code	model	line capacity, mm-m
1709937	10000	0.30-470 / 0.35-345 / 0.40-265

**EVO-X**



code	model	gear ratio	weight, g	max. drag power, kg	ball bearings	line capacity, mm-m
1039020	4000BR	5.1	350	9	7+1	0.22-180 0.25-150 0.29-115
1039021	5000BR	5.1	475	12	7+1	0.31-175 0.33-150 0.37-120



**spool EVO-X**



code	model	line capacity, mm-m
1739915	4000BR	0.22-180 / 0.25-150 / 0.29-115
1739916	5000BR	0.31-175 / 0.33-150 / 0.37-120

**NEW**

### AMULLET SURF



code	model	gear ratio	weight, g	max. drag power, kg	ball bearings	line capacity, mm-m
1039060	10000	4.1:1	640	15	5+1	0.30-460 / 0.40-260 / 0.45-200



**NEW**

### spool AMULLET SURF



code	model	line capacity, mm-m
1739934	10000	0.30-460 / 0.40-260 / 0.45-200

### SKYROS



code	model	gear ratio	weight, g	max. drag power, kg	ball bearings	line capacity, mm-m/#PE-m
1039036	4000S	5.1	305	5	9+1	0.20-120 / 1.0-200
1039037	5000S	5.1	405	7	9+1	0.20-240 / 1.0-400

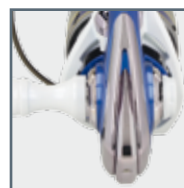

**NEW**

### spool SKYROS



code	model	line capacity, mm-m
1739918	4000S	0.20-120 / 1.0-200
1739919	5000S	0.20-240 / 1.0-400

**MIRROX PE X4 LIME GREEN**

**NEW**



150 m	PE #	test, kg	test, lb
4139330	0.6	4.1	9.2
4139331	0.8	4.9	10.8
4139332	1.0	5.8	12.2
4139333	1.2	6.5	14.4
4139334	1.5	7.8	17.6
4139335	2.0	9.7	21.5
4139336	2.5	12.0	26.1

- color – Lime Green

**MIRROX PE X4 MULTICOLOR**

**NEW**



150 m	PE #	test, kg	test, lb
4139340	0.6	4.1	9.2
4139341	0.8	4.9	10.8
4139342	1.0	5.8	12.2
4139343	1.2	6.5	14.4
4139344	1.5	7.8	17.6
4139345	2.0	9.7	21.5
4139346	2.5	12.0	26.1

- color – Multicolor

**SPRINTER PE X4 LIME GREEN**

**NEW**



150 m	PE #	test, kg	test, lb
4139350	0.6	5.1	11.2
4139351	0.8	5.9	13.0
4139352	1.0	7.8	17.2
4139353	1.2	8.9	19.6
4139354	1.5	10.8	23.8
4139355	2.0	12.4	27.3
4139356	2.5	13.9	30.6

- color – Lime Green

**SPRINTER PE X4 BLUE**



100 m	150 m	PE #	test, kg	test, lb
4139300	4139310	0.6	5.1	11.2
4139301	4139311	0.8	5.9	13.0
4139302	4139312	1.0	7.8	17.2
4139303	4139313	1.2	8.9	19.6
4139304	4139314	1.5	10.8	23.8
4139305	4139315	2.0	12.4	27.3
4139306	4139316	2.5	13.9	30.6

- color – Blue

### INQUISITOR X4 LIME GREEN



100 m	150 m	PE #	test, kg	test, lb
4139000	4139010	0.4	3.2	7.0
4139001	4139011	0.5	4.5	9.0
4139002	4139012	0.6	5.2	11.0
4139003	4139013	0.8	6.0	13.2
4139004	4139014	1.0	8.0	18.0
4139005	4139015	1.2	9.0	20.0
4139006	4139016	1.5	11.0	24.0
4139007	4139017	2.0	12.5	26.0
4139008	4139018	2.5	14.0	31.0

- color – Lime Green

### INQUISITOR X8 LIME GREEN



100 m	150 m	200 m	PE #	test, kg	test, lb
4139040	4139020	4139030	0.6	5.3	11.7
4139041	4139021	4139031	0.8	6.3	13.9
4139042	4139022	4139032	1.0	8.1	17.8
4139043	4139023	4139033	1.2	9.3	20.5
4139044	4139024	4139034	1.5	11.5	23.4
4139045	4139025	4139035	2.0	13.7	30.2
4139046	4139026	4139036	2.5	16.1	35.5

- color – Lime Green

### BIONIC FEEDER PE X4 BLACK



150 m	PE #	test, kg	test, lb
4139320	0.6	5.0	11.0
4139321	0.8	5.8	12.8
4139322	1.0	7.6	16.8
4139323	1.2	8.7	19.2

- color – Black

### BIONIC FEEDER PE X4 ORANGE



150 m	PE #	test, kg	test, lb
4139325	0.6	5.0	11.0
4139326	0.8	5.8	12.8
4139327	1.0	7.6	16.8
4139328	1.2	8.7	19.2

- color – Orange

FLUOROCARBON **X-GUARD FC LEADER**

**NEW**



7 m	10 m	20 m	25 m	diameter, mm	test, kg	test, lb
-	-	3939040	3939000	0.141	1.3	2.9
-	-	3939041	3939001	0.161	1.7	3.7
-	-	3939042	3939002	0.178	2.1	4.6
-	3939020	3939043	3939003	0.205	2.6	5.7
-	3939021	3939044	3939004	0.218	3.1	6.8
-	3939022	3939045	3939005	0.234	3.5	7.7
-	3939023	3939046	3939006	0.257	4.2	9.2
-	3939024	3939047	3939007	0.278	4.7	10.3
-	3939025	3939048	3939008	0.298	5.3	11.7
-	3939026	3939049	3939009	0.333	6.4	14.1
-	3939027	3939050	3939010	0.352	7.0	15.4
-	3939028	3939051	3939011	0.373	7.7	16.9
3939029	-	3939052	3939012	0.418	9.0	19.8
3939030	-	3939053	3939013	0.455	10.7	23.5
3939031	-	3939054	3939014	0.505	13.2	29.0
3939032	-	3939055	-	0.555	15.9	35.0
3939033	-	-	-	0.645	20.4	44.9
3939034	-	-	-	0.738	24.6	54.1

- color – Clear



### EVO-X CARP LEMONCELLO



150 m	300 m	diameter, mm	test, kg	test, lb
4039130	4039140	0.251	6.9	15.2
4039131	4039141	0.286	8.2	18.1
4039132	4039142	0.309	9.5	20.9
4039133	4039143	0.331	10.7	23.6
4039134	4039144	0.370	13.2	29.1
4039135	4039145	0.410	15.6	34.4

- color – Lemoncello

### EVO-X CARP SICILIAN ORANGE



150 m	300 m	diameter, mm	test, kg	test, lb
4039150	4039160	0.261	6.9	15.2
4039151	4039161	0.286	8.2	18.1
4039152	4039162	0.309	9.5	20.9
4039153	4039163	0.331	10.7	23.6
4039154	4039164	0.370	13.2	29.1
4039155	4039165	0.410	15.6	34.4

- color – Sicilian Orange

### EVO-X CARP REAL CAMO



150 m	300 m	diameter, mm	test, kg	test, lb
4039170	4039180	0.261	6.9	15.2
4039171	4039181	0.286	8.2	18.1
4039172	4039182	0.309	9.5	20.9
4039173	4039183	0.331	10.7	23.6
4039174	4039184	0.370	13.2	29.1
4039175	4039185	0.410	15.6	34.4

- color – Real Camo

### EVO-X CARP SWAMP



150 m	300 m	diameter, mm	test, kg	test, lb
4039050	4039061	0.261	6.9	15.2
4039051	4039062	0.286	8.2	18.1
4039052	4039063	0.309	9.5	20.9
4039053	4039064	0.331	10.7	23.6
4039054	4039065	0.370	13.2	29.1
4039055	4039066	0.410	15.6	34.4

- color – Swamp

**VERTE-X FLAT TRUE ORANGE**



300 m	diameter, mm	test, kg	test, lb
4039020	0.234	5.9	13.0
4039021	0.261	7.4	16.3
4039022	0.286	8.7	19.2
4039023	0.309	10.1	22.2
4039024	0.331	11.4	25.1
4039025	0.370	14.0	30.8

- color – True Orange

**VERTE-X FEEDER VENOM**

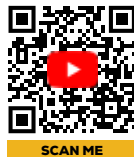

150 m	diameter, mm	test, kg	test, lb
4039010	0.234	5.9	13.0
4039011	0.261	7.4	16.3
4039012	0.286	8.7	19.2
4039013	0.309	10.1	22.2
4039014	0.331	11.4	25.1
4039015	0.370	14.0	30.8

- color – Venom

**VERTE-X MATCH CRYSTALLINE**



150 m	diameter, mm	test, kg	test, lb
4039000	0.148	2.6	5.7
4039001	0.165	3.2	7.0
4039002	0.181	3.8	8.4
4039003	0.203	4.7	10.4
4039004	0.234	6.3	13.9
4039005	0.261	7.8	17.2

- color – Crystalline

**VERTE-X LEADER CRYSTALLINE**



50 m	diameter, mm	test, kg	test, lb
4039030	0.090	1.2	2.6
4039031	0.104	1.4	3.1
4039033	0.128	1.9	4.2
4039034	0.148	2.6	5.7
4039035	0.165	3.2	7.0
4039036	0.181	3.8	8.4
4039037	0.203	4.7	10.4
4039038	0.234	6.3	13.9
4039039	0.261	7.8	17.2

- color – Crystalline

### AMULLET SUMMER SUN

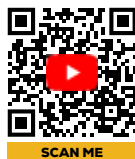

SCAN ME

150 m	300 m	diameter, mm	test, kg	test, lb
4039110	4039120	0.261	7.8	17.2
4039111	4039121	0.286	9.3	20.5
4039112	4039122	0.309	10.7	23.6
4039113	4039123	0.331	12.1	26.7
4039114	4039124	0.370	14.8	32.6
4039115	4039125	0.410	17.5	38.5

- color – Summer Sun

### PASSION POWER REAL CAMO



SCAN ME

100 m	150 m	diameter, mm	test, kg	test, lb
4039070	4039090	0.181	4.2	9.3
4039071	4039091	0.203	5.3	11.7
4039072	4039092	0.234	7.0	15.4
4039073	4039093	0.261	8.7	19.2
4039074	4039094	0.286	10.3	22.7
4039075	4039095	0.309	11.9	26.2
4039076	4039096	0.331	13.4	29.5
4039077	4039097	0.370	16.5	36.3
4039078	4039098	0.410	19.5	43.0
4039079	4039099	0.440	22.8	50.2
4039080	4039100	0.470	25.7	56.6
4039081	-	0.520	29.4	64.8

- color – Real Camo

### WINTER N-ICE LINE CRYSTALLINE



SCAN ME

30 m	50 m	diameter, mm	test, kg	test, lb
4039041	4039200	0.074	0.8	1.7
4039042	4039201	0.090	1.2	2.6
4039043	4039202	0.104	1.4	3.1
4039045	4039203	0.128	1.9	4.2
4039046	4039204	0.148	2.6	5.7
4039047	4039205	0.165	3.2	7.0
4039048	4039206	0.181	3.8	8.4
4039049	4039207	0.203	4.7	10.4

- color – Crystalline



**BULLET ASP**

**NEW**



BULLET ASP – version of the BULLET spoon specially adapted for catching aspicius in strong currents.

The body is made of lead, this allows to increase the weight of spoons without increasing the volume, which positively affects the resistance in the water and increases the casting distance. An eccentric, rigidly fixed body prevents twisting of the line during retrieve. Hook loop is turned in such a way that when you change the treble hook to a single hook, its barb looks upward, which increases the effectiveness of hooks.



01S



02G



03S



04S



06S



07S



08G



09G



11SH



18S



19S

weight	5.0 g	7.0 g	9.0 g	12.0 g
length	30 mm	33 mm	35 mm	39 mm
01S	5438450	5438465	5438480	5438495
02G	5438451	5438466	5438481	5438496
03S	5438452	5438467	5438482	5438497
04S	5438453	5438468	5438483	5438498
06S	5438454	5438469	5438484	5438499
07S	5438455	5438470	5438485	5438500
08G	5438456	5438471	5438486	5438501
09G	5438457	5438472	5438487	5438502
11SH	5438458	5438473	5438488	5438503
18S	5438459	5438474	5438489	5438504
19S	5438460	5438475	5438490	5438505

- body material – lead

**YOKE**

**NEW**



SCAN ME



weight	7.5 g	10.0 g	12.0 g	14.0 g
length	20 mm	23 mm	26 mm	28 mm
11SH	5438800	5438810	5438820	5438830
201	5438801	5438811	5438821	5438831
203	5438802	5438812	5438822	5438832
205	5438803	5438813	5438823	5438833
207	5438804	5438814	5438824	5438834
209	5438805	5438815	5438825	5438835
GC01G	5438806	5438816	5438826	5438836



11SH



201



203



205



207



209

GC01G

**NEW**

### NIBOSHI TROUT / NIBOSHI TROUT STREAM



	Trout	Trout Stream
<b>weight</b>	<b>4.0 g</b>	<b>4.0 g</b>
<b>length</b>	36 mm	36 mm
<b>A50G</b>	5438345	5438415
<b>A51G</b>	5438346	5438416
<b>A52G</b>	5438347	5438417
<b>A53G</b>	5438348	5438418
<b>A54</b>	5438349	5438419
<b>A55B</b>	5438350	5438420
<b>A56W</b>	5438351	5438421
<b>A57B</b>	5438352	5438422
<b>A58</b>	5438353	5438423
<b>A59B</b>	5438354	5438424
<b>A60B</b>	5438355	5438425
<b>A61M</b>	5438356	5438426
<b>A62G</b>	5438357	5438427
<b>A63FY</b>	5438358	5438428

\* **Trout Stream** has a geometry designed for a strong current



Niboshi Trout



Niboshi Trout Stream

### NIBOSHI



<b>weight</b>	<b>7.5 g</b>	<b>12.5 g</b>	<b>15.5 g</b>	<b>20.0 g</b>
<b>length</b>	42 mm	48 mm	52 mm	58 mm
<b>01S</b>	5438220	5438230	5438240	5438250
<b>16G</b>	5438370	5438385	5438400	5438255
<b>201</b>	5438222	5438232	5438242	5438252
<b>207</b>	5438223	5438233	5438243	5438253
<b>210</b>	5438224	5438234	5438244	5438254
<b>211UV</b>	5438371	5438386	5438401	5438256
<b>212UV</b>	5438372	5438387	5438402	5438257
<b>213</b>	5438373	5438388	5438403	5438258
<b>214UV</b>	5438374	5438389	5438404	5438259
<b>GC01</b>	5438375	5438390	5438405	5438260
<b>GCA01</b>	5438221	5438231	5438241	5438251

**NIABI / NIABI MAX**



	Niabi 12.0 g	Niabi Max 12.0 g	Niabi Max 17.0 g
weight	12.0 g	12.0 g	17.0 g
length	57 mm	67 mm	67 mm
<b>02G</b>	5438270	5438280	5438290
<b>03S</b>	5438271	5438281	5438291
<b>08G</b>	5438272	5438282	5438292
<b>10G</b>	5438273	5438283	5438293
<b>16G</b>	5438274	5438284	5438294
<b>GC01G</b>	5438275	5438285	5438295



02G



03S



08G



10G



16G



GC01G

**SIBI**



	10.0 g	13.0 g	17.0 g	21.0 g
weight	10.0 g	13.0 g	17.0 g	21.0 g
length	51 mm	51 mm	60 mm	60 mm
<b>02G</b>	5438300	5438310	5438320	5438330
<b>03S</b>	5438301	5438311	5438321	5438331
<b>08G</b>	5438302	5438312	5438322	5438332
<b>10G</b>	5438303	5438313	5438323	5438333
<b>16G</b>	5438304	5438314	5438324	5438334
<b>GC01G</b>	5438305	5438315	5438325	5438335



02G



03S



08G



10G



16G



GC01G

**HOVER**



SCAN ME



	5.0 g	7.0 g	10.0 g	14.0 g
weight	5.0 g	7.0 g	10.0 g	14.0 g
length	26 mm	26 mm	40 mm	45 mm
<b>S</b>	5438180	5438190	5438200	5438210
<b>G</b>	5438181	5438191	5438201	5438211
<b>08S</b>	5438182	5438192	5438202	5438212
<b>10G</b>	5438183	5438193	5438203	5438213
<b>16G</b>	5438184	5438194	5438204	5438214
<b>17G</b>	5438185	5438195	5438205	5438215
<b>GC01G</b>	5438186	5438196	5438206	5438216
<b>11GSF</b>	-	-	5438207	5438217



S



G



08S



10G



16G



17G



GC01G



11GSF

### ARCANE



weight	17.0 g	30.0 g
length	64 mm	78 mm
<b>02G</b>	5438150	5438160
<b>03S</b>	5438151	5438161
<b>08G</b>	5438152	5438162
<b>10G</b>	5438153	5438163
<b>16G</b>	5438154	5438164
<b>GCO1G</b>	5438155	5438165
<b>210</b>	5438156	-
<b>GCA01</b>	5438157	-



### NIMBLE



weight	6.0 g	8.0 g	10.0 g	15.0 g	20.0 g
length	40 mm	46 mm	50 mm	58 mm	66 mm
<b>01S</b>	5439100	5439120	5439140	5439160	5439180
<b>02G</b>	5439101	5439121	5439141	5439161	5439181
<b>03S</b>	5439102	5439122	5439142	5439162	5439182
<b>04S</b>	5439103	5439123	5439143	5439163	5439183
<b>05G</b>	5439104	5439124	5439144	5439164	5439184
<b>06S</b>	5439105	5439125	5439145	5439165	5439185
<b>07GSF</b>	5439106	5439126	5439146	5439166	5439186
<b>08G</b>	5439107	5439127	5439147	5439167	5439187
<b>09G</b>	5439108	5439128	5439148	5439168	5439188



### BALLISTIC



weight	5.0 g	7.0 g	9.0 g	12.0 g
length	40 mm	44 mm	50 mm	52 mm
<b>01S</b>	5439000	5439030	5439050	5439070
<b>02G</b>	5439001	5439031	5439051	5439071
<b>03S</b>	5439002	5439032	5439052	5439072
<b>04S</b>	5439003	5439033	5439053	5439073
<b>05G</b>	5439004	5439034	5439054	5439074
<b>07GSF</b>	5439005	5439035	5439055	5439075
<b>08G</b>	5439006	5439036	5439056	5439076
<b>09G</b>	5439007	5439037	5439057	5439077
<b>11GSF</b>	5439008	5439038	5439058	5439078



**HORIZON**

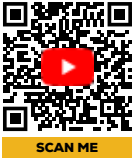

weight	3.5 g	5.0 g	8.0 g	12.0 g	16.0 g	21.0 g
length	30 mm	35 mm	45 mm	52 mm	55 mm	62 mm
<b>01S</b>	5439660	5439670	5439440	5439450	5439460	5439470
<b>03S</b>	5439661	5439671	5439441	5439451	5439461	5439471
<b>04S</b>	5439662	5439672	5439442	5439452	5439462	5439472
<b>06S</b>	5439663	5439673	5439443	5439453	5439463	5439473
<b>09G</b>	5439664	5439674	5439444	5439454	5439464	5439474
<b>201</b>	-	-	5439445	5439455	5439465	-
<b>207</b>	-	-	5439446	5439456	5439466	-
<b>210</b>	-	-	5439447	5439457	5439467	-
<b>GCA01</b>	-	-	5439448	5439458	5439468	-



**WAVE**



weight	4.0 g	8.0 g
length	35 mm	41 mm
<b>01S</b>	5439200	5439220
<b>04S</b>	5439201	5439221
<b>07GSF</b>	5439202	5439222
<b>08G</b>	5439203	5439223
<b>09G</b>	5439204	5439224
<b>11GSF</b>	5439205	5439225



**ACROS**



weight	6.0 g	9.0 g
length	39 mm	48 mm
<b>01S</b>	5439480	5439490
<b>03S</b>	5439481	5439491
<b>04S</b>	5439482	5439492
<b>08G</b>	5439483	5439493
<b>09G</b>	5439484	5439494
<b>11GSF</b>	5439485	5439495

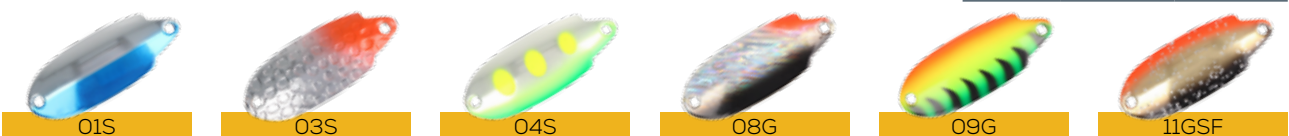

### ZIXE



weight	6.0 g	10.0 g
length	35 mm	45 mm
<b>01S</b>	5439240	5439260
<b>04S</b>	5439241	5439261
<b>07GSF</b>	5439242	5439262
<b>08G</b>	5439243	5439263
<b>09G</b>	5439244	5439264
<b>11GSF</b>	5439245	5439265



01S



04S

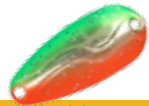

07GSF



08G



09G



11GSF

### MOON



weight	4.5 g	8.0 g	10.0 g	14.0 g
length	36 mm	53 mm	53 mm	62 mm
<b>01S</b>	5439400	5439410	5439420	5439430
<b>02GT</b>	5439401	5439411	5439421	5439431
<b>03ST</b>	5439402	5439412	5439422	5439432
<b>04S</b>	5439403	5439413	5439423	5439433
<b>07GSF</b>	5439404	5439414	5439424	5439434
<b>08G</b>	5439405	5439415	5439425	5439435
<b>10G</b>	5439406	5439416	5439426	5439436
<b>11GSF</b>	5439407	5439417	5439427	5439437



01S



02GT



03ST



04S



07GSF



08G



10G



11GSF

### NATIVE



weight	6.0 g
length	41 mm
<b>01S</b>	5439500
<b>03S</b>	5439501
<b>04S</b>	5439502
<b>06S</b>	5439503
<b>07GSF</b>	5439504
<b>08G</b>	5439505
<b>10G</b>	5439506



01S



03S



04S



06S



07GSF



08G



10G

**BARCHETTA**

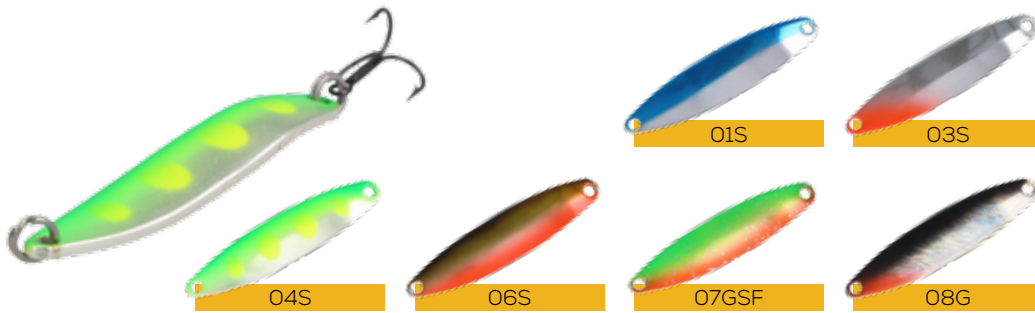

weight	5.0 g
length	46 mm
<b>01S</b>	5439090
<b>03S</b>	5439091
<b>04S</b>	5439092
<b>06S</b>	5439093
<b>07GSF</b>	5439094
<b>08G</b>	5439095

**BENSHA (TROUT)**



weight	1.4 g	2.0 g
length	25 mm	25 mm
<b>A50G</b>	5439520	5439535
<b>A51G</b>	5439521	5439536
<b>A52G</b>	5439522	5439537
<b>A53G</b>	5439523	5439538
<b>A54</b>	5439524	5439539
<b>A55B</b>	5439525	5439540
<b>A56W</b>	5439526	5439541
<b>A57B</b>	5439527	5439542
<b>A58</b>	5439528	5439543
<b>A59B</b>	5439529	5439544
<b>A60B</b>	5439530	5439545
<b>A61M</b>	5439531	5439546
<b>A62G</b>	5439532	5439547
<b>A63FY</b>	5439533	5439548

**HEDIK (TROUT)**



weight	1.8 g	2.6 g
length	28 mm	28 mm
<b>A50G</b>	5439550	5439565
<b>A51G</b>	5439551	5439566
<b>A52G</b>	5439552	5439567
<b>A53G</b>	5439553	5439568
<b>A54</b>	5439554	5439569
<b>A55B</b>	5439555	5439570
<b>A56W</b>	5439556	5439571
<b>A57B</b>	5439557	5439572
<b>A58</b>	5439558	5439573
<b>A59B</b>	5439559	5439574
<b>A60B</b>	5439560	5439575
<b>A61M</b>	5439561	5439576
<b>A62G</b>	5439562	5439577
<b>A63FY</b>	5439563	5439578

### NIASA S / NIASA M (TROUT)



SCAN ME



	Niasa S 1.8 g	Niasa S 2.8 g	Niasa M 2.6 g	Niasa M 3.2 g
length	28 mm	28 mm	30 mm	30 mm
<b>A50G</b>	5439580	5439595	5439610	5439625
<b>A51G</b>	5439581	5439596	5439611	5439626
<b>A52G</b>	5439582	5439597	5439612	5439627
<b>A53G</b>	5439583	5439598	5439613	5439628
<b>A54</b>	5439584	5439599	5439614	5439629
<b>A55B</b>	5439585	5439600	5439615	5439630
<b>A56W</b>	5439586	5439601	5439616	5439631
<b>A57B</b>	5439587	5439602	5439617	5439632
<b>A58</b>	5439588	5439603	5439618	5439633
<b>A59B</b>	5439589	5439604	5439619	5439634
<b>A60B</b>	5439590	5439605	5439620	5439635
<b>A61M</b>	5439591	5439606	5439621	5439636
<b>A62G</b>	5439592	5439607	5439622	5439637
<b>A63FY</b>	5439593	5439608	5439623	5439638

### BULLET



weight	5.0 g	7.0 g
length	32 mm	38 mm
<b>01S</b>	5439300	5439330
<b>02G</b>	5439301	5439331
<b>03S</b>	5439302	5439332
<b>04S</b>	5439303	5439333
<b>05S</b>	5439304	5439334
<b>06S</b>	5439305	5439335
<b>07S</b>	5439306	5439336
<b>08G</b>	5439307	5439337
<b>09G</b>	5439308	5439338
<b>11SH</b>	5439309	5439339
<b>16G</b>	5439310	5439340



**TROX**



weight	3.0 g	4.0 g	6.0 g	8.0 g
length	mm	mm	33 mm	40 mm
<b>01S</b>	5439350	5439370	5439640	5439390
<b>02G</b>	5439351	5439371	5439641	5439391
<b>03S</b>	5439352	5439372	5439642	5439392
<b>04S</b>	5439353	5439373	5439643	5439393
<b>05S</b>	5439354	5439374	5439644	5439394
<b>06S</b>	5439355	5439375	5439645	5439395
<b>07S</b>	5439356	5439376	5439646	5439396
<b>08G</b>	5439357	5439377	5439647	5439397
<b>09G</b>	5439358	5439378	5439648	5439398
<b>11SH</b>	5439359	5439379	5439649	5439399
<b>16G</b>	5439360	5439380	5439650	5439385

**SENSOR**



weight	Sensor 0 3.5 g	Sensor 1 6.5 g	Sensor 2 9.5 g
length	25 mm	30 mm	40 mm
<b>03S</b>	5438030	5438045	5438060
<b>04SO</b>	5438031	5438046	5438061
<b>06S</b>	5438032	5438047	5438062
<b>08G</b>	5438033	5438048	5438063
<b>09G</b>	5438034	5438049	5438064
<b>12S</b>	5438035	5438050	5438065
<b>13S</b>	5438036	5438051	5438066

**CORRIDA**



weight	Corrida 1 2.5 g	Corrida 2 4.0 g	Corrida 3 7.0 g
length	20 mm	27 mm	35 mm
<b>03S</b>	5438075	5438090	5438105
<b>04SO</b>	5438076	5438091	5438106
<b>06S</b>	5438077	5438092	5438107
<b>08G</b>	5438078	5438093	5438108
<b>09G</b>	5438079	5438094	5438109
<b>12S</b>	5438080	5438095	5438110
<b>13S</b>	5438081	5438096	5438111

### TWIST



	Twist 1 4.0 g	Twist 2 6.0 g	Twist 3 9.0 g
weight	4.0 g	6.0 g	9.0 g
length	23 mm	29 mm	33 mm
<b>03S</b>	5439700	5439715	5439730
<b>04SO</b>	5439701	5439716	5439731
<b>06S</b>	5439702	5439717	5439732
<b>08G</b>	5439703	5439718	5439733
<b>09G</b>	5439704	5439719	5439734
<b>12S</b>	5439705	5439720	5439735
<b>13S</b>	5439706	5439721	5439736

### JAZZ



	Jazz 2 4.5 g	Jazz 3 6.5 g
weight	4.5 g	6.5 g
length	29 mm	32 mm
<b>03S</b>	5438120	5438130
<b>04SO</b>	5438121	5438131
<b>06S</b>	5438122	5438132
<b>08G</b>	5438123	5438133
<b>09G</b>	5438124	5438134
<b>12S</b>	5438125	5438135
<b>13S</b>	5438126	5438136

### SKILL



	Skill 3 6.5 g	Skill 4 11.0 g
weight	6.5 g	11.0 g
length	33 mm	40 mm
<b>03S</b>	5438000	5438015
<b>04SO</b>	5438001	5438016
<b>06S</b>	5438002	5438017
<b>08G</b>	5438003	5438018
<b>09G</b>	5438004	5438019
<b>12S</b>	5438005	5438020
<b>13S</b>	5438006	5438021

### SPINNERBAIT BUMBLEBEE

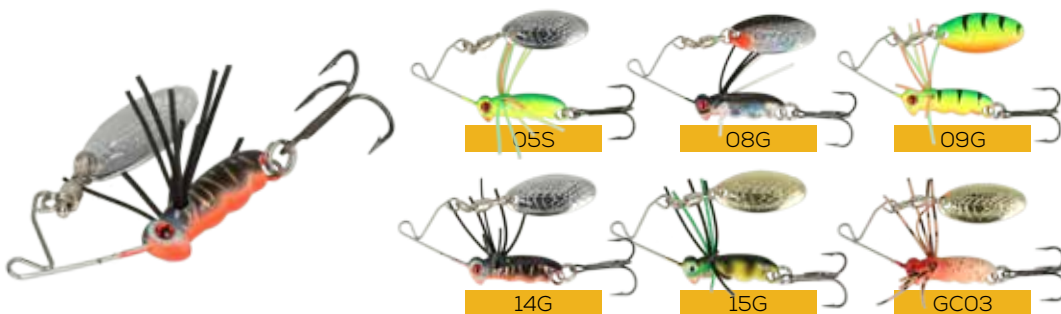

	weight 7.0 g
length	22 mm
<b>05S</b>	5439740
<b>08G</b>	5439741
<b>09G</b>	5439742
<b>14G</b>	5439743
<b>15G</b>	5439744
<b>GC03</b>	5439745

**DASHER HEAVY**



weight	20.0 g	30.0 g	40.0 g	50.0 g
length	67 mm	78 mm	86 mm	92 mm
<b>205</b>	5438730	5438740	5438750	5438760
<b>206</b>	5438731	5438741	5438751	5438761
<b>207</b>	5438732	5438742	5438752	5438762
<b>210</b>	5438733	5438743	5438753	5438763
<b>211</b>	5438734	5438744	5438754	5438764

205 206 207 210 211

**DASHER**



SCAN ME



201

weight	7.0 g	10.0 g	15.0 g
length	47 mm	52 mm	60 mm
<b>201</b>	5438640	5438650	5438660
<b>202</b>	5438641	5438651	5438661
<b>203</b>	5438642	5438652	5438662
<b>204</b>	5438643	5438653	5438663
<b>205</b>	5438644	5438654	5438664
<b>206</b>	5438645	5438655	5438665
<b>207</b>	5438646	5438656	5438666
<b>208</b>	5438647	5438657	5438667
<b>209</b>	5438648	5438658	5438668
<b>210</b>	5438649	5438659	5438669
<b>211</b>	5438673	5438676	5438670



202 203 (UV) 204 205 206 (glow)  
207 208 (glow) 209 (glow) 210 211

**SALTY KING**



SCAN ME



201

weight	5.0 g	7.0 g	10.0 g
length	40 mm	45 mm	50 mm
<b>201</b>	5438680	5438690	5438700
<b>202</b>	5438681	5438691	5438701
<b>203</b>	5438682	5438692	5438702
<b>204</b>	5438683	5438693	5438703
<b>205</b>	5438684	5438694	5438704
<b>206</b>	5438685	5438695	5438705
<b>207</b>	5438686	5438696	5438706
<b>208</b>	5438687	5438697	5438707
<b>209</b>	5438688	5438698	5438708
<b>210</b>	5438689	5438699	5438709
<b>211</b>	5438713	5438716	5438710



202 203 (UV) 204 205 206 (glow)  
207 208 (glow) 209 (glow) 210 211

## BLAZE



SCAN ME



weight	5.0 g	7.0 g	12.0 g
length	39 mm	44 mm	53 mm
201	5438600	5438610	5438620
202	5438601	5438611	5438621
203	5438602	5438612	5438622
204	5438603	5438613	5438623
205	5438604	5438614	5438624
206	5438605	5438615	5438625
207	5438606	5438616	5438626
208	5438607	5438617	5438627
209	5438608	5438618	5438628
210	5438609	5438619	5438629
211	5438633	5438636	5438630



## FERINA



SCAN ME

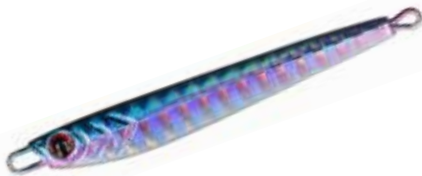

weight	3.0 g	5.0 g	7.0 g	8.5 g	10.5 g
length	26 mm	34 mm	41 mm	44 mm	55 mm
101	5439860	5439870	5439910	5439890	5439900
102G	5439861	5439871	5439911	5439891	5439901
103	5439862	5439872	5439912	5439892	5439902
104	5439863	5439873	5439913	5439893	5439903
105G	5439864	5439874	5439914	5439894	5439904
106G	5439865	5439875	5439915	5439895	5439905
107	5439866	5439876	5439916	5439896	5439906



## SANDEEL



weight	5.0 g	7.0 g	11.0 g
length	38 mm	43 mm	50 mm
101	5439920	5439930	5439940
102G	5439921	5439931	5439941
103	5439922	5439932	5439942
104	5439923	5439933	5439943
105G	5439924	5439934	5439944
106G	5439925	5439935	5439945
107	5439926	5439936	5439946



**ARROW**



SCAN ME



weight	5.0 g	7.0 g	12.0 g	14.0 g
length	35 mm	39 mm	47 mm	50 mm
<b>101</b>	5439810	5439820	5439830	5439840
<b>102G</b>	5439811	5439821	5439831	5439841
<b>103</b>	5439812	5439822	5439832	5439842
<b>104</b>	5439813	5439823	5439833	5439843
<b>105G</b>	5439814	5439824	5439834	5439844
<b>106G</b>	5439815	5439825	5439835	5439845
<b>107</b>	5439816	5439826	5439836	5439846

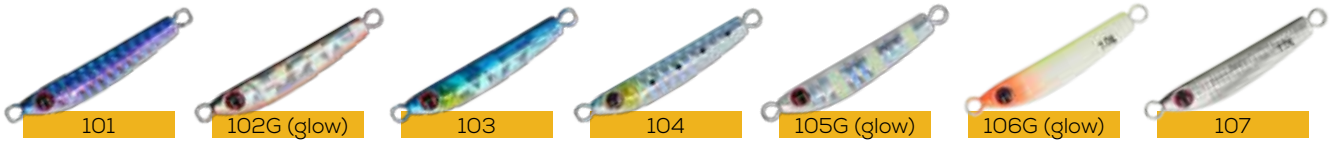

**NORDIC FJORD**

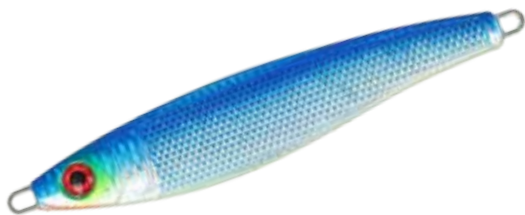

weight	300.0 g	400.0 g
length	145 mm	170 mm
<b>NP001</b>	5439750	5439760
<b>NP002</b>	5439751	5439761
<b>NP003</b>	5439752	5439762
<b>NP004G</b>	5439753	5439763



**STINGER**



weight	300.0 g	500.0 g
length	200 mm	240 mm
<b>NP001</b>	5439770	5439780
<b>NP002</b>	5439771	5439781
<b>NP003</b>	5439772	5439782
<b>NP004G</b>	5439773	5439783

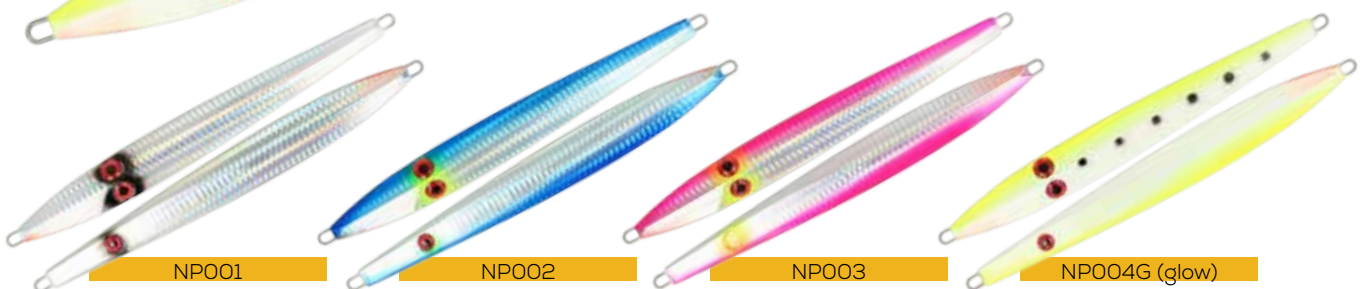

### N-ICE JIG



SCAN ME



weight	7.0 g	11.0 g	21.0 g	28.0 g
length	40 mm	50 mm	67 mm	80 mm
<b>B101</b>	5438900	5438915	5438925	5438935
<b>B102</b>	5438901	5438916	5438926	5438936
<b>B103</b>	5438902	5438917	5438927	5438937
<b>B201</b>	5438903	5438918	5438928	5438938
<b>B202</b>	5438904	5438919	5438929	5438939
<b>B203</b>	5438905	5438920	5438930	5438940
<b>B204</b>	5438906	5438921	5438931	5438941



**NEW**

### ready rig for silicone **STINGER HARD**

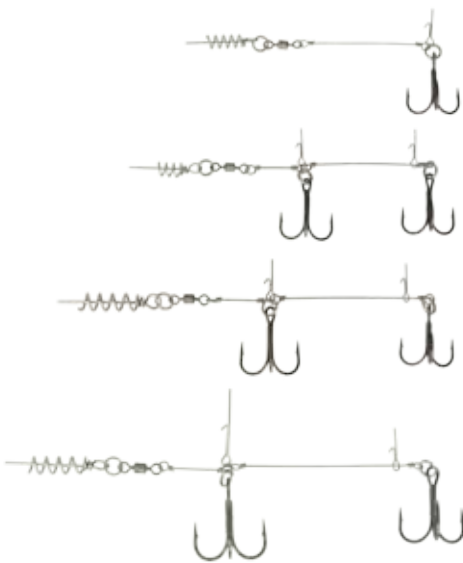

code	4339200	4339201	4339202	4339203
model	SH-70SS	SH-95SS	SH-115SS	SH-130SS
length, mm	70	95	115	130
wire diameter, mm	0.6	0.8	0.8	0.8
size, cm	14-16	17-19	19-21	22-24
hook, N°	2	2 + 2	1 + 2	2/0 + 1/0
test, kg	20	25	30	30
test, lb	44	55	66	66

- material - stainless steel

**NEW**

### **STINGER SPIKE SS**



code	size	length, mm	wire diameter, mm
1639300	M	16	0.6
1639301	L	18	0.8
1639302	XL	33	1.0

**AJI SABIKI FS10**

code	hook, N°	hooks, pcs	length, cm
4339030	6	5	120
4339031	8	5	120
4339050	6	10	200
4339051	8	10	200

- color – Natural Glow
- diameter of line – 0.25 mm
- length of leader – 3 cm
- natural fish skin



**AJI SABIKI S20**

code	hook, N°	hooks, pcs	length, cm
4339034	6	5	120
4339035	8	5	120
4339052	6	10	200
4339053	8	10	200

- color – Pink Glow
- diameter of line – 0.25 mm
- length of leader – 3 cm



**AJI SABIKI S30**

code	hook, N°	hooks, pcs	length, cm
4339038	6	5	120
4339039	8	5	120
4339054	6	10	200
4339055	8	10	200

- color – Green Glow
- diameter of line – 0.25 mm
- length of leader – 3 cm



**AJI SABIKI F40**

code	hook, N°	hooks, pcs	length, cm
4339042	6	5	120
4339043	8	5	120
4339056	6	10	200
4339057	8	10	200

- color – Multicolor Glow
- diameter of line – 0.25 mm
- length of leader – 3 cm







**DOUBLE LONG L2037BN**

**NEW**



N°	8	6	4	2	1	1/0	2/0
pcs/pack	8	8	8	6	6	6	6
code	5547760	5547761	5547762	5547763	5547764	5547765	5547766

- coating – Black Nickel



SCAN ME

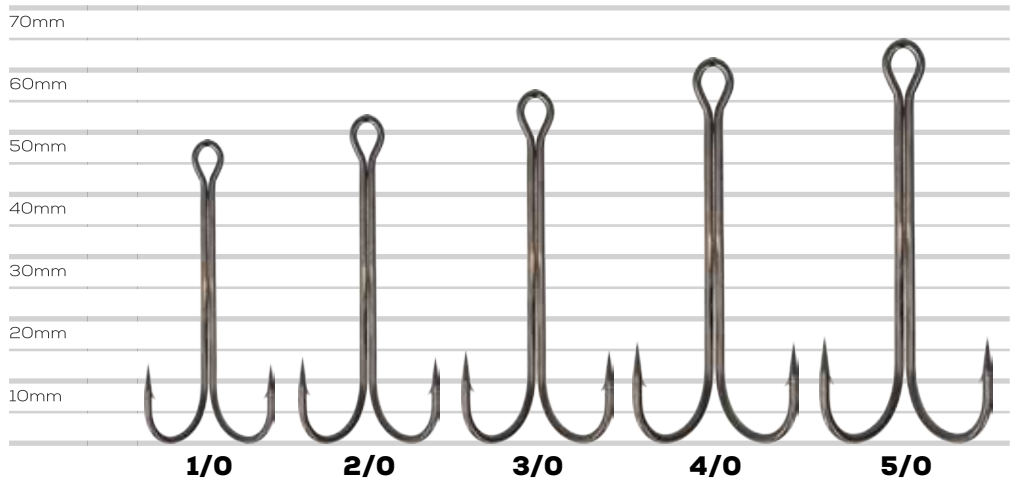
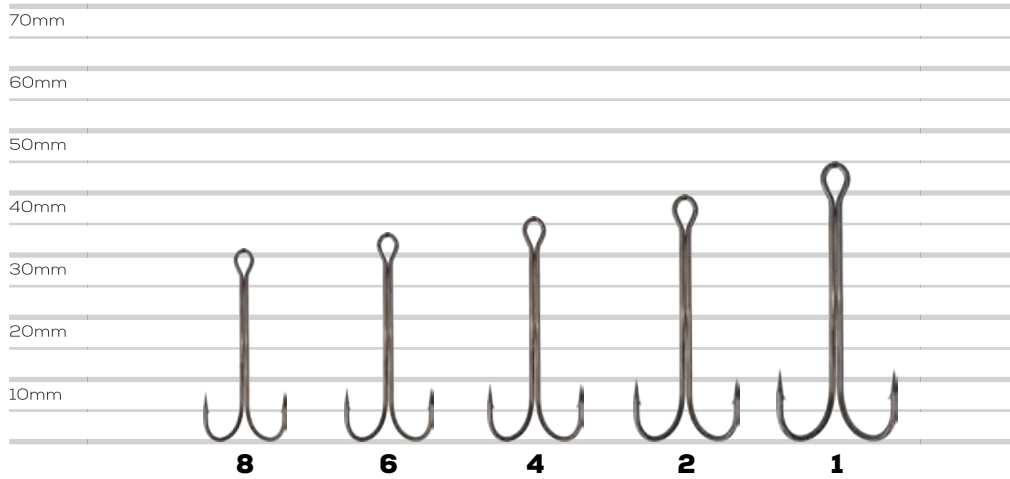

## FEEDER S 110NI



code	N°
5547520	15
5547521	12
5547522	11
5547523	10
5547524	9
5547525	8
5547526	7
5547527	6



- 12 pcs/pack
- coating - Nickel

## FEEDER S 1120NI



code	N°
5547530	12
5547531	11
5547532	10
5547533	9
5547534	8
5547535	7
5547536	6
5547537	5



- 12 pcs/pack
- coating - Nickel

## FEEDER S 1130NI



code	N°
5547540	15
5547541	14
5547542	12
5547543	10
5547544	8
5547545	6
5547546	5



- 12 pcs/pack
- coating - Nickel

## FEEDER S 1140NI



code	N°
5547550	14
5547551	13
5547552	12
5547553	11
5547554	10
5547555	9
5547556	8
5547557	7



- 12 pcs/pack
- coating - Nickel

## FEEDER S 1150NI



code	N°
5547560	15
5547561	14
5547562	12
5547563	11
5547564	10
5547565	9
5547566	8
5547567	7
5547568	6
5547569	5



- 12 pcs/pack
- coating - Nickel

## FEEDER S 1155NI



code	N°
5547570	16
5547571	15
5547572	14
5547573	12
5547574	11
5547575	10



- 12 pcs/pack
- coating - Nickel

**FEEDER 1011BN**



SCAN ME



code	N°
5547580	15
5547581	14
5547582	12
5547583	11
5547584	10
5547585	9
5547586	8
5547587	7
5547588	6

- 12 pcs/pack
- coating - Black Nickel



**FEEDER 1021BN**



SCAN ME



code	N°
5547600	12
5547601	11
5547602	10
5547603	8
5547604	7
5547605	6
5547606	5
5547607	4
5547608	3
5547609	2
5547610	1

- 12 pcs/pack
- coating - Black Nickel



**FEEDER 1030BN**



SCAN ME



code	N°
5547590	16
5547591	15

- 12 pcs/pack
- coating - Black Nickel

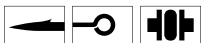

**FEEDER 1040BN**



SCAN ME



code	N°
5547630	11
5547631	10
5547632	9
5547633	8
5547634	7
5547635	6
5547636	5

- 12 pcs/pack
- coating - Black Nickel



**FEEDER 1051BN**



SCAN ME



code	N°
5547615	14
5547616	12
5547617	11
5547618	10
5547619	8
5547620	6
5547621	5
5547622	4
5547623	3
5547624	2
5547625	1

- 12 pcs/pack
- coating - Black Nickel

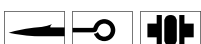

**FEEDER 1061BN**



SCAN ME



code	N°
5547640	16
5547641	15
5547642	14
5547643	13
5547644	12
5547645	11
5547646	10
5547647	9
5547648	8
5547649	6

- 12 pcs/pack
- coating - Black Nickel



## FEEDER BASIC 1053BN



SCAN ME

code	N°
5547805	14
5547804	12
5547803	10
5547802	8
5547801	6
5547800	4



- 10 pcs/pack
- coating - Black Nickel

## FEEDER BASIC 1223BN



SCAN ME

code	N°
5547815	14
5547814	12
5547813	10
5547812	8
5547811	6
5547810	4



- 10 pcs/pack
- coating - Black Nickel

## FEEDER BASIC 50457BN



SCAN ME

code	N°
5547824	14
5547823	12
5547822	10
5547821	8
5547820	6



- 10 pcs/pack
- coating - Black Nickel

## FEEDER BASIC 50922BN



SCAN ME

code	N°
5547835	14
5547834	12
5547833	10
5547832	8
5547831	6
5547830	4



- 10 pcs/pack
- coating - Black Nickel

## FEEDER BASIC 53117BN



SCAN ME

code	N°
5547846	14
5547845	12
5547844	10
5547843	8
5547842	6
5547841	4
5547840	2



- 10 pcs/pack
- coating - Black Nickel

## FEEDER BASIC F-22BN



SCAN ME

code	N°
5547854	14
5547853	12
5547852	10
5547851	8
5547850	6



- 10 pcs/pack
- coating - Black Nickel

## FEEDER BASIC F-314BN



SCAN ME

code	N°
5547877	14
5547876	12
5547875	10
5547874	8
5547873	6
5547872	4
5547871	2
5547870	1



- 10 pcs/pack
- coating - Black Nickel

## FEEDER BASIC F-31BN



SCAN ME

code	N°
5547865	14
5547864	12
5547863	10
5547862	8
5547861	6
5547860	4



- 10 pcs/pack
- coating - Black Nickel

**SKILFUL**



code	N°	pcs/pack
5547440	9	13
5547441	8	12
5547442	7	11
5547443	6	10
5547444	5	10
5547445	4	10
5547446	3	9
5547447	2	8

- coating - Black Nickel



**BEAK**



code	N°	pcs/pack
5547130	16	13
5547131	14	13
5547132	12	12
5547133	10	12
5547134	8	10
5547135	6	8
5547136	4	7
5547137	2	7

- coating - Black Nickel

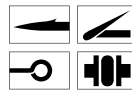

**BIG CLAW**



code	N°	pcs/pack
5547315	11	14
5547316	10	14
5547317	9	13
5547318	8	13
5547319	7	12
5547320	6	10

- coating - Black Nickel



**BIG GAME**



code	N°	pcs/pack
5547425	10	10
5547426	8	9
5547427	6	8
5547428	4	7
5547429	2	6

- coating - Black Nickel



**ALLROUND**



code	N°	pcs/pack
5547040	12	12
5547041	11	12
5547042	10	12
5547043	9	12
5547044	8	12
5547045	7	12
5547046	6	12
5547047	5	12

- coating - Black Nickel

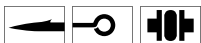

**BULLY**



code	N°	pcs/pack
5547140	9	12
5547141	8	12
5547142	7	10
5547143	6	10
5547144	5	9
5547145	4	9
5547146	3	7
5547147	2	7
5547148	1	6
5547149	1/0	6

- coating - Black Nickel



### CARP 1001BN



code	N°	pcs/pack
5547500	10	10
5547501	8	10
5547502	6	9
5547503	4	6
5547504	2	5

- coating - Black Nickel

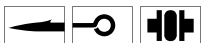

### CARP 1002BN



code	N°	pcs/pack
5547505	10	10
5547506	8	10
5547507	6	9
5547508	4	6
5547509	2	5

- coating - Black Nickel



### CARP 1003BN



code	N°	pcs/pack
5547510	6	10
5547511	4	8
5547512	2	7

- coating - Black Nickel



### CARPER



code	N°	pcs/pack
5547435	8	9
5547436	6	8
5547437	4	7
5547438	2	6

- coating - Black Nickel



### DEFT TRAP



code	N°	pcs/pack
5547230	9	12
5547231	8	12
5547232	7	11
5547233	6	11
5547234	5	10
5547235	4	10
5547236	3	8
5547237	2	7
5547238	1	6
5547239	1/0	5

- coating - Black Nickel

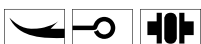

### BAITHOLDER



code	N°	pcs/pack
5547060	8	10
5547061	6	9
5547062	4	8
5547063	2	7

- coating - Black Nickel

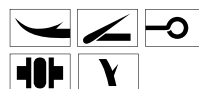

**BULLHEAD**



SCAN ME

code	N°	pcs/pack
5547150	10	11
5547151	8	10
5547152	6	9
5547153	4	8
5547154	2	8
5547155	1	6

- coating - Black Nickel



**SEA FISH**

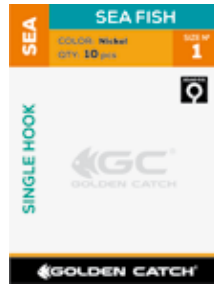

SCAN ME

code	N°	pcs/pack
5547690	1	10
5547691	1/0	10
5547692	2/0	10
5547693	3/0	10

- coating - Nickel



**SINGLE JIG LIGHT 1212BN**



SCAN ME

code	N°	pcs/pack
5547025	12	11
5547026	10	11
5547027	8	10
5547028	6	10

- coating - Black Nickel



**SINGLE JIG 1259BN**



SCAN ME

code	N°	pcs/pack
5547035	8	11
5547036	6	10
5547037	4	9
5547038	2	8

- coating - Black Nickel



**SINGLE WORM 1234BN**



SCAN ME

code	N°	pcs/pack
5547702	2	6
5547701	1	6
5547700	1/0	5

- coating - Black Nickel



### SKINNY RIP 4078BN

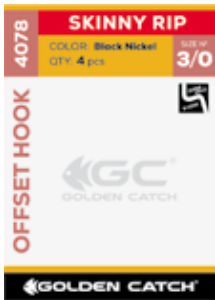

SCAN ME

code	N°	pcs/pack
5547723	1	5
5547722	1/0	5
5547721	2/0	4
5547720	3/0	4

- coating - Black Nickel



### DEKAPPARI 4093BN

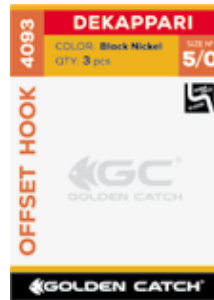

SCAN ME

code	N°	pcs/pack
5547744	1/0	5
5547743	2/0	4
5547742	3/0	4
5547741	4/0	3
5547740	5/0	3

- coating - Black Nickel



### OKAPPARI 4091BN

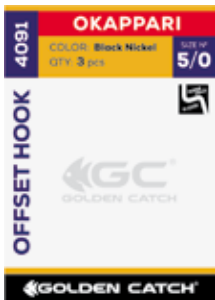

SCAN ME

code	N°	pcs/pack
5547737	4	6
5547736	2	6
5547735	1	5
5547734	1/0	5
5547733	2/0	4
5547732	3/0	4
5547731	4/0	3
5547730	5/0	3

- coating - Black Nickel



### WORM 4094BN

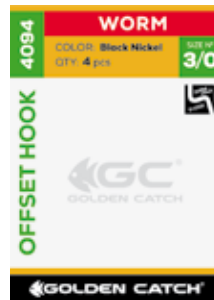

SCAN ME

code	N°	pcs/pack
5547756	6	7
5547755	4	7
5547754	2	6
5547753	1	5
5547752	1/0	6
5547751	2/0	5
5547750	3/0	4

- coating - Black Nickel







**DOUBLE 2036BN DOUBLE 2036TN**



N°	code BN	pcs/pack	code TN	pcs/pack
10	5547775	5	5547975	10
8	5547774	5	5547974	10
6	5547773	5	5547973	8
4	5547772	4	5547972	8
2	5547771	4	5547971	6
1	5547770	4	5547970	6

- coating **BN** – Black Nickel
- coating **TN** – Tin

**TREBLE 3036BN**



code	N°	pcs/pack
5547790	20	6
5547789	18	6
5547788	16	6
5547787	14	6
5547786	12	6
5547785	10	6
5547784	8	6
5547783	6	6
5547782	5	6
5547781	4	6
5547780	2	6

- coating – Black Nickel

### DISMOUNTABLE LOAD



code	weight, g	pcs/pack
5202110	1.0	10
5202111	1.5	10
5202112	2.0	10
5202113	3.0	10
5202114	4.0	10
5202115	5.0	10
5202136	6.0	10
5202137	7.0	10
5202138	8.0	10
5202139	10.0	6
5202140	12.0	6
5202141	14.0	6
5202142	16.0	6

- without coating



code	weight, g	pcs/pack
5202050	1.0	5
5202051	1.5	5
5202052	2.0	5
5202053	3.0	5
5202054	4.0	4
5202055	5.0	3

code	weight, g	pcs/pack
5202160	1.0	10
5202161	1.5	10
5202163	3.0	10
5202164	4.0	10
5202165	5.0	10

- coating – gold



code	weight, g	pcs/pack
5202030	1.0	5
5202031	1.5	5
5202032	2.0	5
5202034	4.0	4
5202040	5.0	10
5202035	5.0	3

- coating – Black Nickel



code	weight, g	pcs/pack
5202010	1.0	5
5202011	1.5	5
5202012	2.0	5
5202013	3.0	5
5202014	4.0	4
5202015	5.0	3

- without coating

### SET OF DISMOUNTABLE LOADS



code	weight, g	pcs/pack
5202020	1-5	6

- without coating

### JIG-RIG TEAR



code	weight, g	pcs/pack
5202220	3.5	10
5202221	5.5	10
5202222	7.0	10
5202223	9.0	10
5202224	10.5	6
5202225	14.0	6

- without coating

### JIG-RIG STICK



code	weight, g	pcs/pack
5202200	3.5	10
5202201	5.3	10
5202202	7.2	10
5202203	10.6	6
5202204	14.0	6

- without coating

# FLOATS

## A01



code	model	load capacity, g	length, mm
6070005	A01-015	1.5	145
6070006	A01-020	2.0	155
6070007	A01-025	2.5	170

- type – fixed
- material of stem – graphite
- material – balsa
- detachable antenna – no

## A02



code	model	load capacity, g	length, mm
6070009	A02-020	2.0	180
6070010	A02-030	3.0	195
6070011	A02-040	4.0	210
6070012	A02-060	6.0	220
6070013	A02-080	8.0	240

- type – fixed
- material of stem – graphite
- material – balsa
- detachable antenna – no

## A03

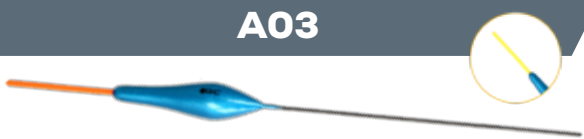

code	model	load capacity, g	length, mm
6070020	A03-008	0.8	180
6070021	A03-010	1.0	185
6070022	A03-015	1.5	190
6070023	A03-020	2.0	205
6070024	A03-025	2.5	210
6070025	A03-030	3.0	215

- type – fixed
- material of stem – graphite
- material – balsa
- detachable antenna – no

## A04



code	model	load capacity, g	length, mm
6070029	A04-008	0.8	180
6070030	A04-010	1.0	190
6070031	A04-020	2.0	200
6070032	A04-030	3.0	210
6070033	A04-040	4.0	220

- type – fixed
- material of stem – graphite
- material – balsa
- detachable antenna – yes

## A05



code	model	load capacity, g	length, mm
6070040	A05-020	2.0	150
6070041	A05-030	3.0	160
6070042	A05-040	4.0	170
6070043	A05-050	5.0	180

- type – fixed
- material of stem – graphite
- material – balsa
- detachable antenna – yes

## A10



code	model	load capacity, g	length, mm
6070045	A10-010	1.0	165
6070046	A10-020	2.0	190
6070047	A10-030	3.0	200
6070048	A10-040	4.0	215

- type – fixed
- material of stem – graphite
- material – balsa
- detachable antenna – no

## A11



code	model	load capacity, g	length, mm
6070135	A11-010	1.0	210
6070136	A11-020	2.0	225
6070137	A11-030	3.0	235
6070138	A11-040	4.0	250

- type – fixed
- material of stem – graphite
- material – balsa
- detachable antenna – no

## A12



code	model	load capacity, g	length, mm
6070140	A12-010	1.0	140
6070141	A12-015	1.5	150
6070142	A12-020	2.0	155
6070143	A12-025	2.5	160
6070144	A12-030	3.0	165

- type – fixed
- material of stem – graphite
- material – balsa
- detachable antenna – no

### A13



code	model	load capacity, g	length, mm
6070145	A13-007	0.7	165
6070146	A13-010	1.0	175
6070147	A13-015	1.5	180
6070148	A13-020	2.0	185
6070149	A13-030	3.0	190

- type – fixed
- material – balsa
- material of stem – graphite
- detachable antenna – no

### A14



code	model	load capacity, g	length, mm
6070150	A14-010	1.0	155
6070151	A14-015	1.5	160
6070152	A14-020	2.0	165
6070153	A14-025	2.5	170
6070154	A14-030	3.0	180

- type – fixed
- material – balsa
- material of stem – graphite
- detachable antenna – no

### A15



code	model	load capacity, g	length, mm
6070155	A15-010	1.0	170
6070156	A15-015	1.5	180
6070157	A15-020	2.0	185
6070158	A15-025	2.5	195

- type – fixed
- material – balsa
- material of stem – graphite
- detachable antenna – no

### A16



code	model	load capacity, g	length, mm
6070160	A16-008	0.8	190
6070161	A16-010	1.0	195
6070162	A16-015	1.5	200
6070163	A16-020	2.0	205
6070164	A16-025	2.5	210

- type – fixed
- material – balsa
- material of stem – graphite
- detachable antenna – no

### A17



code	model	load capacity, g	length, mm
6070165	A17-020	2.0	175
6070166	A17-025	2.5	180
6070167	A17-030	3.0	195
6070168	A17-035	3.5	205
6070169	A17-040	4.0	175

- type – fixed
- material – balsa
- material of stem – graphite
- detachable antenna – no

### A18



code	model	load capacity, g	length, mm
6070170	A18-020	2.0	180
6070171	A18-025	2.5	185
6070172	A18-030	3.0	195
6070173	A18-040	4.0	205
6070174	A18-050	5.0	225

- type – fixed
- material – balsa
- material of stem – graphite
- detachable antenna – no

### A19



code	model	load capacity, g	length, mm
6070175	A19-015	1.5	190
6070176	A19-020	2.0	195
6070177	A19-025	2.5	200
6070178	A19-030	3.0	215
6070179	A19-040	4.0	225

- type – fixed
- material – balsa
- material of stem – graphite
- detachable antenna – no

### A20



code	model	load capacity, g	length, mm
6070180	A20-040	4.0	250
6070181	A20-050	5.0	255
6070182	A20-060	6.0	255
6070183	A20-070	7.0	260
6070184	A20-080	8.0	280
6070185	A20-100	10.0	280

- type – fixed
- material – polyurethane
- material of stem – metal
- detachable antenna – no

## FLOATS

### B01



code	model	load capacity, g	length, mm
6070050	B01-010	1.0	185
6070051	B01-015	1.5	195
6070052	B01-020	2.0	205
6070053	B01-025	2.5	215

- type – sliding
- material of stem – plastic
- material – balsa
- detachable antenna – no

### B02



code	model	load capacity, g	length, mm
6070060	B02-030	3.0	235
6070061	B02-040	4.0	245
6070062	B02-050	5.0	255
6070063	B02-060	6.0	265

- type – sliding
- material of stem – plastic
- material – balsa
- detachable antenna – no

### B03



code	model	load capacity, g	length, mm
6070070	B03-010	1.0	100
6070071	B03-015	1.5	115
6070072	B03-020	2.0	125

- type – sliding
- material of stem – plastic
- material – balsa
- detachable antenna – no

### B04



code	model	load capacity, g	length, mm
6070079	B04-020	2.0	185
6070080	B04-025	2.5	190
6070081	B04-035	3.5	195
6070082	B04-045	4.5	205
6070083	B04-055	5.5	210

- type – sliding
- material of stem – plastic
- material – balsa
- detachable antenna – no

### B05



code	model	load capacity, g	length, mm
6070090	B05-015	1.5	190
6070091	B05-020	2.0	200
6070092	B05-025	2.5	215
6070093	B05-030	3.0	220

- type – sliding
- material of stem – plastic
- material – balsa
- detachable antenna – no

### B06



code	model	load capacity, g	length, mm
6070099	B06-020	2.0	190
6070100	B06-025	2.5	195
6070101	B06-030	3.0	215
6070102	B06-035	3.5	220
6070103	B06-040	4.0	230
6070104	B06-050	5.0	235
6070105	B06-060	6.0	240

- type – sliding
- material of stem – plastic
- material – balsa
- detachable antenna – no

### B07



code	model	load capacity, g	length, mm
6070110	B07-040	4.0	255
6070111	B07-060	6.0	275
6070112	B07-080	8.0	295
6070113	B07-100	10.0	310

- type – sliding
- material of stem – plastic
- material – balsa
- detachable antenna – no

### B08



code	model	load capacity, g	length, mm
6070120	B08-010	1.0	160
6070121	B08-020	2.0	185
6070122	B08-030	3.0	195
6070123	B08-040	4.0	200

- type – sliding
- material of stem – plastic
- material – balsa
- detachable antenna – no

### B10



code	model	load capacity, g	length, mm
6070125	B10-020	2.0	180
6070126	B10-030	3.0	190
6070127	B10-040	4.0	195
6070128	B10-050	5.0	200

- type – sliding
- material of stem – plastic
- material – balsa
- detachable antenna – no

### B11



code	model	load capacity, g	length, mm
6070190	B11-010	1.0	150
6070191	B11-015	1.5	155
6070192	B11-020	2.0	160
6070193	B11-025	2.5	165
6070194	B11-030	3.0	175

- type – sliding
- material of stem – plastic
- material – balsa
- detachable antenna – no

### C01



code	model	load capacity, g	length, mm
6070130	C01-202	2+2	240
6070131	C01-203	2+3	240
6070132	C01-204	4+2	260
6070133	C01-303	3+3	270
6070134	C01-205	2+5	260

- type – sliding, loaded
- material of stem – metal
- material – balsa
- detachable antenna – no

### D10



code	model	load capacity, g	length, mm
6070195	D10-200	20	215
6070196	D10-300	30	225
6070197	D10-400	40	235

- type – sliding
- material of stem – plastic
- material – balsa
- detachable antenna – no

### D11



code	model	load capacity, g	length, mm
6070200	D11-200	20	280
6070201	D11-300	30	290
6070202	D11-400	40	305

- type – sliding
- material of stem – plastic
- material – balsa
- detachable antenna – no



**FT-01C**



code	load capacity, g	Ø of main line, mm	Ø of leader, mm	hook N°
4370020	1.0	0.18	0.16	8
4370021	2.0	0.18	0.16	8
4370022	3.0	0.20	0.18	8
4370023	4.0	0.23	0.20	8

- length of main line – 7 m
- length of leader – 0.2 m
- material of stem – carbon
- detachable antenna – no

**FT-02S**



code	load capacity, g	Ø of main line, mm	Ø of leader, mm	hook N°
4370030	1.0	0.18	0.16	8
4370031	2.0	0.18	0.16	8
4370032	3.0	0.20	0.18	8
4370033	4.0	0.23	0.20	8
4370034	5.0	0.23	0.20	8

- length of main line – 7 m
- length of leader – 0.2 m
- material of stem – stainless steel
- detachable antenna – no

**FT-03C**

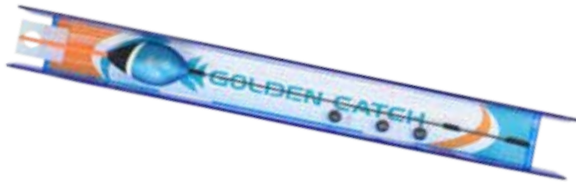

code	load capacity, g	Ø of main line, mm	Ø of leader, mm	hook N°
4370040	0.75	0.18	0.16	8
4370041	1.0	0.18	0.16	8
4370042	1.5	0.18	0.16	8
4370043	2.0	0.18	0.16	8
4370044	3.0	0.20	0.18	8

- length of main line – 7 m
- length of leader – 0.2 m
- material of stem – carbon
- detachable antenna – no

**FT-04S**



code	load capacity, g	Ø of main line, mm	Ø of leader, mm	hook N°
4370050	3.0	0.20	0.18	8
4370051	4.0	0.20	0.18	8
4370052	5.0	0.23	0.20	8
4370053	6.0	0.23	0.20	8

- length of main line – 7 m
- length of leader – 0.2 m
- material of stem – stainless steel
- detachable antenna – no

BOMBARD FLOAT **GOLDEN CATCH**



code	weight, g	length, mm	code	weight, g	length, mm	code	weight, g	length, mm
6070900	5.0	150	6070920	5.0	150	6070910	5.0	150
6070901	8.0	150	6070921	8.0	150	6070911	8.0	150
6070902	10.0	150	6070922	10.0	150	6070912	10.0	150
6070903	15.0	180	6070923	15.0	180	6070913	15.0	180
6070904	20.0	180	6070924	20.0	180	6070914	20.0	180
6070905	25.0	200	6070925	25.0	200	6070915	25.0	200

- type – FLOATING
- material – plastic

- type – SLOW SINKING
- material – plastic

- type – SINKING
- material – plastic

### 1022MB ROUND SNAP

N°	000	00	0	1
test, kg	6	9	12	16
pcs/pack	12	12	12	12
code	4520110	4520111	4520112	4520113

- coating - Matt Black

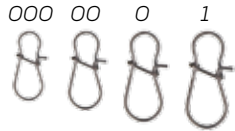

### 1023SS WIDE SNAP

N°	000	00	0	1
test, kg	8	12	16	20
pcs/pack	12	12	12	12
code	4520120	4520121	4520122	4520123

- coating - Stainless Steel

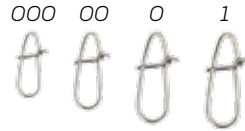

### 1020BN AMERICAN

N°	000	00	0
test, kg	4	9	12
pcs/pack	12	12	12
code	4520030	4520031	4520032

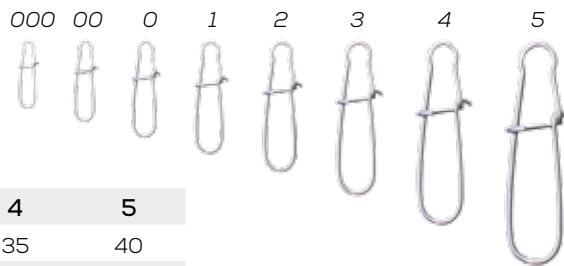

N°	1	2	3	4	5
test, kg	18	25	30	35	40
pcs/pack	12	12	10	10	8
code	4520033	4520034	4520035	4520036	4520037

- coating - Black Nickel

### 1021BN DUAL LOCK

N°	0	1	2	3
test, kg	8	14	22	35
pcs/pack	12	12	12	12
code	4520090	4520091	4520092	4520093

- coating - Black Nickel

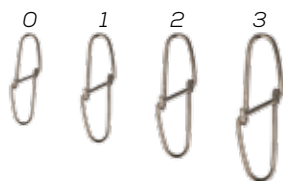

### 1010BN KNOTLESS

N°	S	M	L	XL
test, kg	12	18	25	35
pcs/pack	10	10	10	10
code	4520080	4520081	4520082	4520083

- coating - Black Nickel

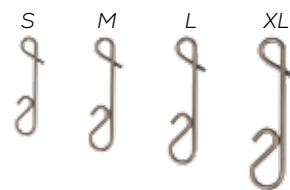



**1050BN AMERICAN WITH SWIVEL**

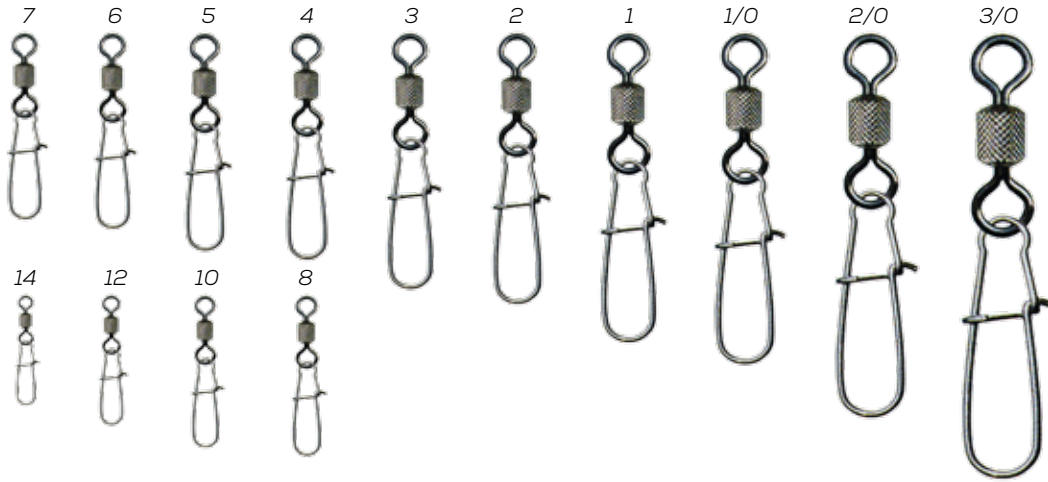

N°	14	12	10	8	7	6	5
test, kg	4	9	12	12	18	18	25
pcs/pack	12	12	12	12	10	10	10
code	4509355	4509354	4509353	4509352	4509351	4509350	4509349

N°	4	3	2	1	1/0	2/0	3/0
test, kg	25	30	30	35	35	40	50
pcs/pack	10	8	8	6	6	4	4
code	4509348	4509347	4509346	4509345	4509344	4509343	4509342

N°	14	12	10	8	7	6	5	4	3	2	1
test, kg	4	9	12	12	18	18	25	25	30	30	35
pcs/pack	1000	1000	1000	1000	1000	1000	1000	1000	1000	1000	1000
code	4520555	4520554	4520553	4520552	4520551	4520550	4520549	4520548	4520547	4520546	4520545

- coating – Black Nickel

**1051BN GROSS WITH SWIVEL**

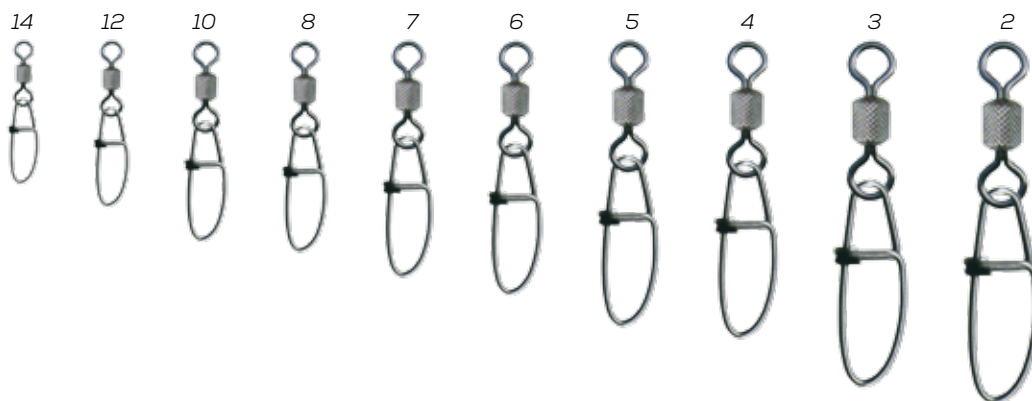

N°	14	12	10	8	7	6	5	4	3	2
test, kg	4	6	10	10	15	15	30	30	40	40
pcs/pack	9	9	9	9	7	7	7	7	5	5
code	4520010	4520009	4520008	4520007	4520006	4520005	4520004	4520003	4520002	4520001

- coating – Black Nickel

### 3010BL FLOAT

code	N°	pcs/pack
4509369	S	10

- coating - Black Nickel



### 3015BN FLOAT

code	N°	pcs/pack
4520072	S	5

- coating - Black Nickel



### 3015G FLOAT

code	N°	pcs/pack
4520073	S	5

- coating - Gold



### 3020BL FLOAT

code	N°	pcs/pack
4520076	S	5

- coating - Black Nickel



### 3030BL STOPPER

code	N°	pcs/pack
1620063	SSS	9
1620062	SS	9
1620060	S	9
1620061	M	9

- Black



### 3035CL STOPPER

code	N°	pcs/pack
1620065	SSS	9
1620066	SS	9
1620067	S	9
1620068	M	9

- Clear



### 1042BN HIGH SPEED

N°	10	8	6	4
test, kg	14	19	27	35
pcs/pack	12	12	12	12
code	4420203	4420202	4420201	4420200

- type - double
- coating - Black Nickel

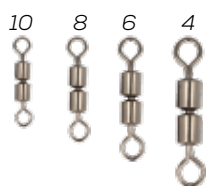

### 1043BN HIGH SPEED

N°	12	10	7	5
test, kg	9	14	22	32
pcs/pack	12	12	12	12
code	4420213	4420212	4420211	4420210

- type - triple
- coating - Black Nickel

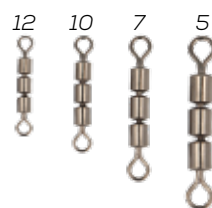

**1040BN AMERICAN**

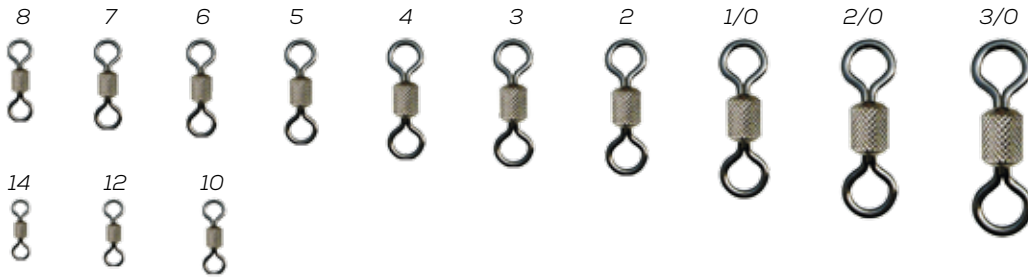

N°	14	12	10	8
test, kg	4	9	14	19
pcs/pack	12	12	12	12
code	4409536	4409535	4409534	4409533

N°	7	6	5	4	3	2	1/0	2/0	3/0
test, kg	22	27	32	35	40	43	60	75	100
pcs/pack	12	12	10	10	10	8	6	6	6
code	4409532	4409531	4409530	4409529	4409528	4409527	4409525	4409524	4409523

N°	14	12	10	8	7	6	5	4	3
test, kg	4	9	14	19	22	27	32	35	40
pcs/pack	1000	1000	1000	1000	1000	1000	1000	1000	1000
code	4420536	4420535	4420534	4420533	4420532	4420531	4420530	4420529	4420528

- coating – Black Nickel

**1045BN TRIPLE**

N°	6	5	4	3	2
test, kg	27	32	35	40	43
pcs/pack	10	10	10	10	10
code	4420014	4420013	4420012	4420011	4420010

N°	6	5	4	3	2
test, kg	27	32	35	40	43
pcs/pack	1000	1000	1000	1000	1000
code	4420574	4420573	4420572	4420571	4420570



- coating – Black Nickel

**1046BN TRIPLE WITH BEADS**

N°	10x12	7x8	5x6
test, kg	9	19	30
pcs/pack	5	5	5
code	4420042	4420041	4420040

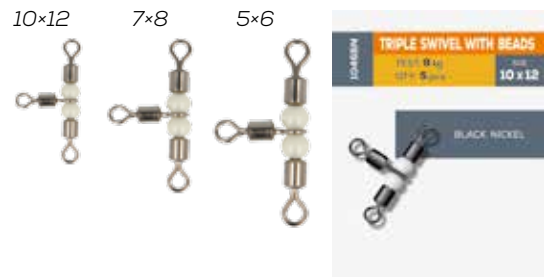

- coating – Black Nickel

### SPLIT RING 1030BN

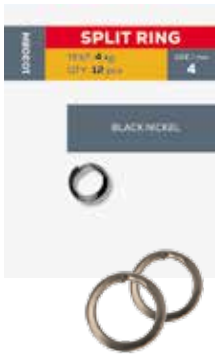

code	N°	test, kg
2120100	4	4
2120101	4.5	5
2120102	5	8
2120103	6	12
2120104	7	15
2120105	8	20

- 12 pcs/pack
- type - forged
- coating - Black Nickel

### BRASS TUBE 1060BN



code	N°	test, kg
1620600	0.6	10
1620601	0.8	10
1620602	1.0	10
1620603	1.2	10
1620604	1.4	10

- 30 pcs/pack
- coating - Black Nickel

### LEADER TITANIUM



code	length, cm	diameter, mm	test, kg
4239000	15	0.30	10
4239001	20	0.30	10
4239002	25	0.30	10
4239010	15	0.40	15
4239011	20	0.40	15
4239012	25	0.40	15
4239020	20	0.50	20
4239021	25	0.50	20

- 2 pcs/pack
- material - titan

### SOFT BAIT FIXERS GOLDEN CATCH

#### GC-1072P

code	size
1665650	17 mm

- 12 pcs/pack
- material - plastic



#### GC-1071SS

code	size
1665660	L

- 20 pcs/pack
- material - stainless steel



#### 1070SS

code	size
1620020	M
1620021	L

- 20 pcs/pack
- material - stainless steel

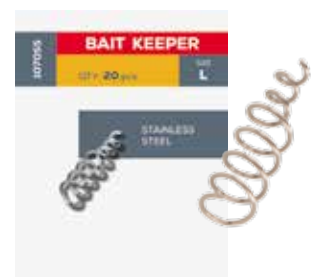

**CATFISH LEADER**



code	length, m	diameter, mm	test, kg	test, lb
4165200	20	0.7	50	110
4165201	20	1.0	80	170
4165202	20	1.2	100	220
4165203	20	1.4	150	330

**BIG BAIT CATFISH RIG**



code	N° of hook	length, cm	test, kg	test, lb	diameter of leader, mm
4365275	6/0	100	100	220	1.2
4365276	8/0	100	100	220	1.2

Special rig for catching catfish with livebaits or deadbaits. It composed of a powerful leader, swivel, 2 trebles and 1 single hook.

**DOUBLE HOOK CATFISH RIG**



code	N° of hook	length, cm	test, kg	test, lb	diameter of leader, mm
4365255	6/0	100	100	220	1.2
4365256	8/0	100	100	220	1.2
4365257	10/0	100	100	220	1.2

Rig for catching catfish with livebaits or deadbaits. Ideal for fishing with large baits. It is composed of two hooks, leader and swivel.

**SINGLE AND TREBLE CATFISH RIG**



code	N° of hook	length, cm	test, kg	test, lb	diameter of leader, mm
4365270	6/0	100	100	220	1.2
4365271	8/0	100	100	220	1.2

Special rig for catching catfish with livebait near the bottom. It can be used on streaming water and on standing water. Composed of powerful leader, swivel, treble and single hooks.

### SINGLE HOOK CATFISH RIG WITH RATTLE



code	N° of hook	length, cm	test, kg	test, lb	diameter of leader, mm
4365250	4/0	100	100	220	1.2
4365251	6/0	100	100	220	1.2
4365252	8/0	100	100	220	1.2

Can be used with any kind of bait for all catfish fishing methods. It is composed of powerful leader with reliable swivel, single hook and small rattle capsule.

### TREBLE HOOK CATFISH RIG WITH RATTLE



code	N° of hook	length, cm	test, kg	test, lb	diameter of leader, mm
4365265	5/0	100	100	220	1.2
4365266	6/0	100	100	220	1.2

Can be used with any kind of bait for all catfish fishing methods. It is composed of powerful leader with reliable swivel, treble hook and small rattle capsule.

### SINGLE HOOK TEXAS CATFISH RIG



code	N° of hook	length, cm	test, kg	test, lb	diameter of leader, mm
4365260	4/0	100	100	220	1.2
4365261	6/0	100	100	220	1.2
4365262	8/0	100	100	220	1.2

Special readymade rig with single hook and underwater float developed to catch catfish near the bottom. Thanks to the underwater float, the bait is located just above the bottom and it prevents rig getting hooked in woods or rocks. The rig is suitable for use on streaming water and on standing water.

### CATFISH FLOAT

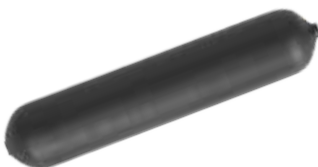

code	load capacity, g	pcs/pack
6065060	10	2
6065061	20	2
6065062	30	2

**CLASSIC FEEDER**



code	3139100	3139101	3139105	3139106	3139107
size	M	M	XL	XL	XL
weight, g	20	30	40	50	60

code	3139108	3139109	3139110	3139111	3139112
size	XL	XL	XL	XL	XL
weight, g	70	80	90	100	120

**GRIP FEEDER**



code	3139140	3139141	3139142	3139143	3139145
size	M	M	M	M	L
weight, g	50	70	90	110	90

code	3139146	3139147	3139148	3139150	3139151	3139152
size	L	L	L	XL	XL	XL
weight, g	100	120	150	140	160	180

**DISTANCE FEEDER**



code	3139120	3139121	3139122	3139123	3139124
size	M	M	M	M	M
weight, g	30	40	50	60	70

code	3139130	3139131	3139132	3139133	3139134
size	L	L	L	L	L
weight, g	50	60	70	80	100

**FLAT METHOD FEEDER IN LINE**



code	3139006	3139007	3139010	3139011	3139012	3139013	3139014
size	S	S	L	L	L	L	L
weight, g	20	30	20	30	40	50	60

code	3139030	3139031	3139015	3139016	3139017	3139020	3139021	3139022
size	L	L	XL	XL	XL	XXL	XXL	XXL
weight, g	70	80	60	70	80	90	100	110

**METHOD FEEDER**



code	1639005	1639006	1639007	1639008
size	S	L	XL	XXL

### 4010BL BLACK



code	size, mm	pcs/pack
1620035	70	2
1620036	90	2

- color - Black
- material - brass

### 4020FL FLUO

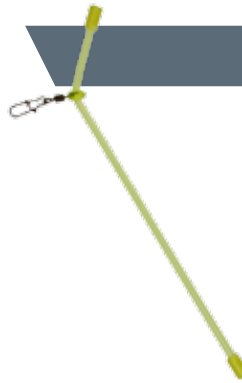

code	size, mm	pcs/pack
1620030	85	2
1620031	120	2

- color - Fluo
- material - plastic

### FEEDER GUM



code BL	code CL	length, m	diameter, mm
4165100	4165105	10	0.6
4165101	4165106	8	0.8
4165102	4165107	7	1.0

- color BL - Black
- color CL - Clear

### QUICK CHANGE BEADS



code	size
1665550	S (9 mm)
1665551	M (11.5 mm)

- 10 pcs/pack

### SWIVEL STOP BEADS



code	size
1665225	S
1665226	M

- 10 pcs/pack

### FEEDER SNAP LINKS



code	size
4565005	L

- 10 pcs/pack

### BAIT STING



code	length, mm
1665310	7
1665311	10

- 10 pcs/pack

### BAIT BANDER



code
1665380

### BAIT BAND

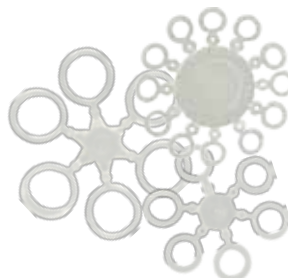

code	size
1665455	S
1665456	M
1665457	L

- S - 60 pcs/pack
- M - 30 pcs/pack
- L - 30 pcs/pack



**LIGHT STICK**



code	model	dimensions, mm	pcs/pack
1639215	LP	4.5×37	2
1639200	ST	4.0×37	2
1639201	ST	4.5×37	2
1639205	ST	4.5×37	5

- color – Green

**BOILIE NEEDLE KIT 5 IN 1**



code	1665320
------	---------

**BAIT DRILL**



code	1665326
------	---------

- diameter – 1.45 mm
- length – 40 mm

**POP-UP FLAVORED CORN IN DIP**



code	flavour
3065060	chocolate
3065061	garlic
3065062	honey
3065063	pineapple
3065064	shrimp
3065065	strawberry
3065066	sweetcorn

- size – 8 mm
- 12 pcs/pack

code	flavour
3065050	chocolate
3065051	garlic
3065052	honey
3065053	pineapple
3065054	shrimp
3065055	strawberry
3065056	sweetcorn
3065057	acid pear
3065058	pepper
3065059	squid

- size – 10 mm
- 12 pcs/pack

**POP-UP TRIPLE CORN IN DIP**



code	flavour
3065070	chocolate
3065071	garlic
3065072	honey
3065073	pineapple
3065074	shrimp
3065075	strawberry
3065076	sweetcorn

- 18 pcs/pack

**POP-UP CORN**



code	color
3065080	yellow

- 12 pcs/pack

**NEW**

### DISGORGER WITH NEEDLE



code	length, mm	pcs/pack
1665078	170	1

### DOUBLE SLIDER WINDERS



code	length, cm
1665605	20
1665606	26

- 10 pcs/pack

### MARKER FLOAT KIT



code	6065050
• length – 205 mm	
• diameter – 18 mm	
• material – plastic	
• removable antenna	

### BOILIE CRUSHER 2 IN 1



code	dimensions, cm
1665340	8.5x12

- material of body – plastic
- material of blades – steel

**HELI RIGS**



code	4365020
length, cm	75
test, lb	50
color	camo green
pcs/pack	3

- rig

**LEADCORE SAFETY CLIP LEADER**



code	4365015
length, cm	75
test, lb	50
color	camo green
pcs/pack	3

- rig

**LOOPED LEADCORE**



code	4365010
length, cm	75
test, lb	50
color	camo green
pcs/pack	3

- rig

**DOUBLE LOOPED LEADCORE**



code	4365013
length, cm	75
test, lb	50
color	camo green
pcs/pack	3

- rig

**LOOPED LEADCORE**



code	4365005	4365006
length, cm	80	80
test, lb	45	45
color	camo brown	camo green
pcs/pack	2	2

- rig

### PVA BAG

code	dimensions, mm	pcs/pack
3236600	70×100	10
3236601	70×120	10
3236602	85×140	10



Time of full dissolve at temperature +20 °C up to 25 secs

### PVA MESH

code (tube) KIT	code (winder) REFILL	diameter, mm
3236570	3236574	18
3236571	3236575	25

- length – 5 m



Time of full dissolve at temperature +20 °C up to 20-30 secs

### BOILIE STOPS

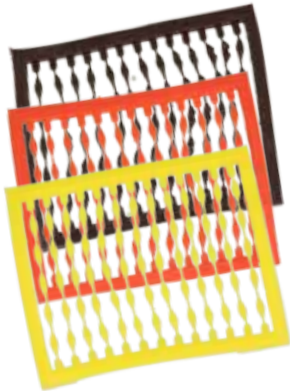

code	color
1620090	brown
1620091	red
1620092	yellow

- 130 pcs/pack

### BOILIE HAIR EXTENDER STOPS



code	color
1620085	brown
1620086	clear
1620087	green

- 126 pcs/pack

### BOILIE HAIR STOPS

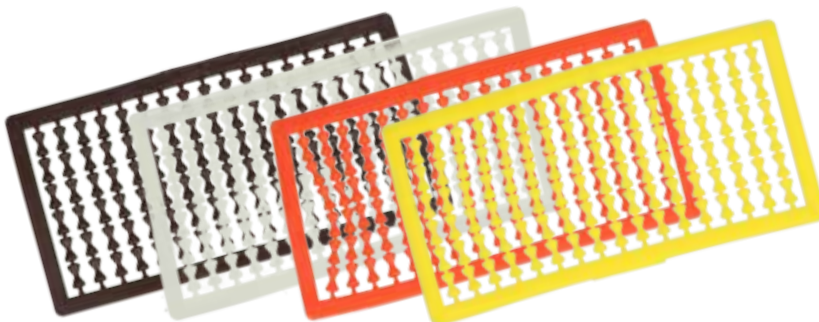

code	color
1620080	brown
1620081	clear
1620082	red
1620083	yellow

- 204 pcs/pack

**2010HB QUICK CHANGE CLIP**



code	N°	pcs/pack
4520100	M	10

- color - Matt Black

**SILICONE TUBE**



code	Ø, mm	color
1620570	0.5	brown
1620571	0.5	green
1620572	0.8	brown
1620573	0.8	green

- length - 1.0 m

**ANTI TANGLE SLEEVES SOFT**



code	size	length, mm	color
1620557	L	55	brown
1620558	L	55	green
1620555	M	40	brown
1620556	M	40	green

- 15 pcs/pack

**SHRINK TUBE**



code	Ø, mm	color
1620580	1.2-0.4	brown
1620581	1.2-0.4	clear
1620582	1.2-0.4	green
1620585	2.4-0.8	brown
1620586	2.4-0.8	clear
1620587	2.4-0.8	green
1620590	2.8-1.0	brown
1620591	2.8-1.0	clear
1620592	2.8-1.0	green

- length - 60 mm
- 15 pcs/pack

**JARS FOR BOILIES**



code	1634751
material	PVC white / aluminum
capacity, g	140
pcs/pack	4

### SWINGER SW06S

code	color of LED
6534870	■ - yellow
6534871	■ - green
6534872	■ - red
6534873	■ - blue



### SWINGER SW08S

code	color of LED
6534945	■ - yellow
6534946	■ - green
6534947	■ - red
6534948	■ - blue



BITE ALARM SET **SN-55\*4**



code	6534754
pieces	4+1

- Tone, volume and sensitivity adjustment
- Memory function
- Power output
- Water resistant
- Low battery warning
- Night mode
- 9 volt batteries (not included)

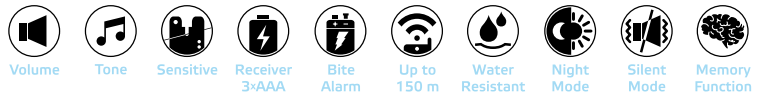

BITE ALARM SET **SN-65\*4**



code	6534755
pieces	4+1

- Tone, volume and sensitivity adjustment
- Power output
- Water resistant
- Low battery warning
- Night mode
- 7 options of color for light indication
- 9 volt batteries (not included)

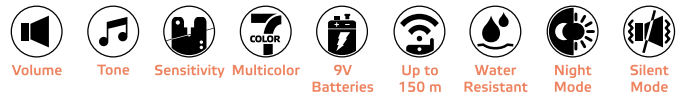

BITE ALARM **S-11**

code	color of LED
6534805	■ - yellow
6534806	■ - green
6534807	■ - red
6534808	■ - blue

- Tone, volume and sensitivity adjustment
- Water resistant
- 9 volt batteries (not included)



BITE ALARM **S-21**

code	color of LED
6534810	■ - yellow
6534811	■ - green
6534812	■ - red
6534813	■ - blue

- Tone, volume and sensitivity adjustment
- Power output
- Water resistant
- 9 volt batteries (not included)







ROD POD **GC SUPER STRONG 3/4 RODS**



code	6730006
material	aluminum
length, cm	92-150
height, cm	40-130 (min 30)
width, cm	68
weight, kg	6.0



ROD POD **COMPACT 4\*4**



code	6730005
material	aluminum
length, cm	70-128
height, cm	50-80
width, cm	50
carry tube size, cm	95*12
weight, kg	3.8



**SURF SAND ROD HOLDER**

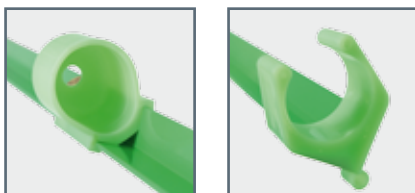

code	6733010
length, m	1.30

### AREA CARBON OV50402005R



SCAN ME

code	6633340
model	OV50402005R
maximum length, cm	250
pieces	5
folded, cm	54
material of handle	graphite
sizes of head, cm	50×40
material of head	graphite
material of mesh	silicone
sizes of cells, mm	15×20
depth of net, cm	30
color of mesh	clear
weight, g	570

- folding
- graphite head
- telescopic graphite handle
- transportation length only 54 cm
- 30% lighter compared to metal landing nets
- silicone net doesn't harm fish and trebles do not stuck



### COMPACT OVSK4050902P



code	6633353
model	OVSK4050902P
maximum length, cm	140
pieces	2
folded, cm	60
material of handle	aluminum
sizes of head, cm	50×40
material of mesh	rubber
sizes of cells, mm	6×6
depth of net, cm	30
color of mesh	black
weight, g	485

- folding
- soft handle made of EVA
- fast folding system
- waist clip

**KVSK70601802P**

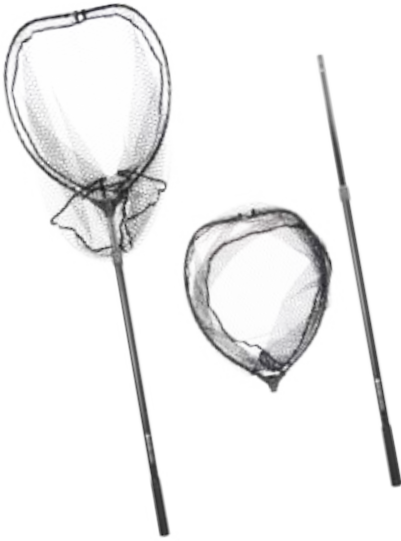

code	6633352
model	KVSK70601802P
maximum length, cm	250
pieces	2
folded, cm	110
material of handle	aluminum
sizes of head, cm	70×60
material of mesh	rubber
sizes of cells, mm	20×20
depth of net, cm	60
color of mesh	black
weight, g	1220

- folding
- soft handle made of EVA

**KV60501201P**

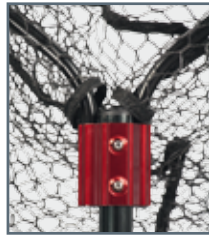
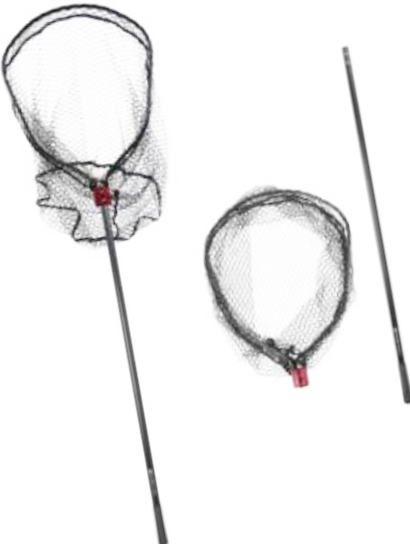

code	6633350
model	KV60501201P
maximum length, cm	180
pieces	1
folded, cm	123
material of handle	aluminum
sizes of head, cm	60×50
material of mesh	rubber
sizes of cells, mm	20×20
depth of net, cm	60
color of mesh	black
weight, g	830

- folding

**KV80701201P**

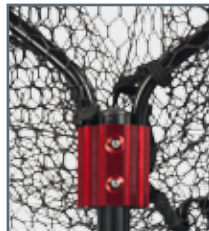
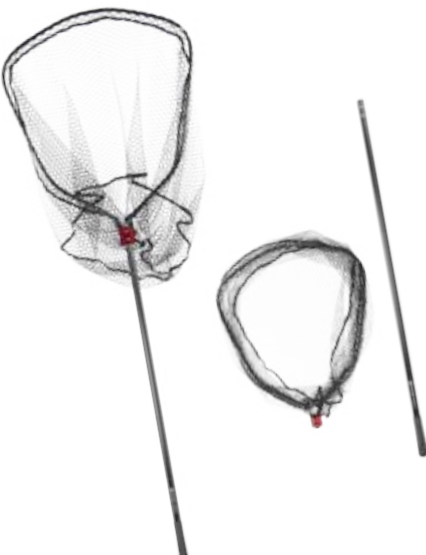

code	6633351
model	KV80701201P
maximum length, cm	200
pieces	1
folded, cm	121
material of handle	aluminum
sizes of head, cm	80×70
material of mesh	rubber
sizes of cells, mm	20×20
depth of net, cm	70
color of mesh	black
weight, g	1080

- folding

### KV80701802P

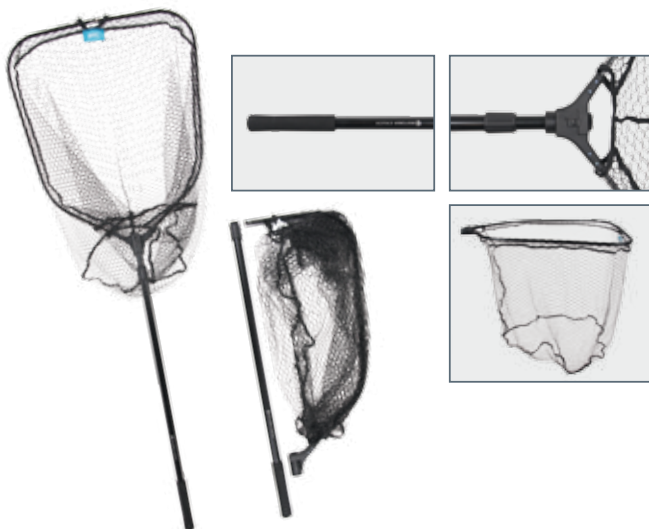

code	6633354
model	KV80701802P
maximum length, cm	260
pieces	2
folded, cm	105
material of handle	aluminum
sizes of head, cm	80×70
material of head	aluminum
material of mesh	rubber
sizes of cells, mm	18×18
depth of net, cm	90
color of mesh	black
weight, g	1260

- folding

### MONSTER CARBON KVSK70601802P

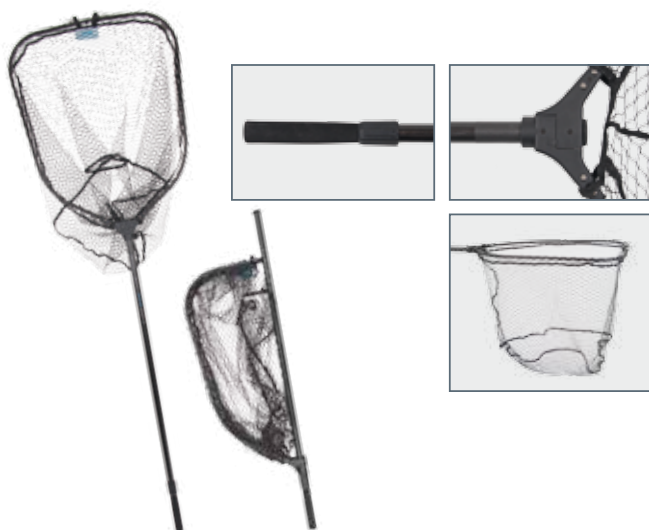

code	6633342
model	KVSK70601802P
maximum length, cm	250
pieces	2
folded, cm	118
material of handle	graphite
sizes of head, cm	70×60
material of head	graphite
material of mesh	rubber
sizes of cells, mm	18×18
depth of net, cm	70
color of mesh	black
weight, g	920

- folding

### GC AREA



code	6633355
model	OV45381001R
maximum length, cm	145
pieces	1
folded, cm	101
material of handle	aluminum
sizes of head, cm	45×38
material of mesh	silicone
sizes of cells, mm	15×15
color of mesh	clear
weight, g	640

- folding

**WANDERER**

code	model	length, m	folded, cm	pcs	weight, g	type	material
6633074	WANDERER 250	2.50	61	5	290	tele	graphite



**BIONIC**

code	model	length, m	folded, cm	pcs	weight, g	type	material
6633061	BIONIC 200	2.00	109	2	170	put over	graphite
6633062	BIONIC 300	3.00	123	3	266	put over	graphite
6633063	BIONIC 400	4.00	120	4	390	put over	graphite



**SUPERHARD**

code	model	length, m	folded, cm	pcs	weight, g	length fixation	material
6633054	SUPERHARD 210	2.10	114	2	270	yes	graphite
6633055	SUPERHARD 300	3.00	118	3	392	yes	graphite



**COMPETITION**

code	model	length, m	folded, cm	pcs	weight, g	length fixation	material
6633050	LANDING NET HANDLE 210	2.10	115	2	184	yes	graphite
6633051	LANDING NET HANDLE 240	2.40	117	3	233	yes	graphite
6633052	LANDING NET HANDLE 270	2.70	117	3	248	yes	graphite
6633053	LANDING NET HANDLE 300	3.00	117	3	260	yes	graphite

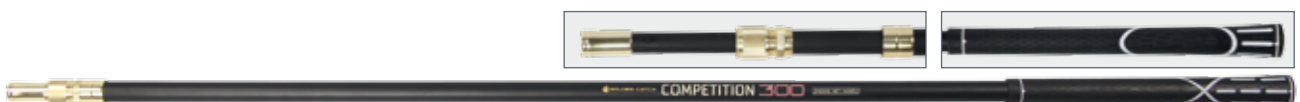

### LANDING NET HEAD **SAPPHIRE AIR**



code	6633015	6633016
model	OV504030L	OV554535L
sizes of head, cm	50×40	55×45
material of head	aluminum	aluminum
material of mesh	nylon line	nylon line
sizes of cells, mm	7×7	7×7
depth of net, cm	30	35
color of mesh	clear	clear
weight, g	123	135

### LANDING NET HEAD **SAPPHIRE FLOAT**

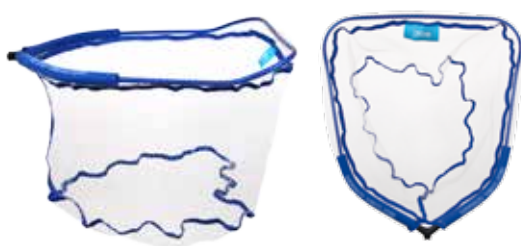

code	6633010	
model	KV504530L Float	
sizes of head, cm	50×45	
material of head	aluminum	
material of mesh	nylon line	
sizes of cells, mm	7×7	
depth of net, cm	30	
color of mesh	clear	
weight, g	160	

### LANDING NET HEAD **SAPPHIRE**



code	6633011	6633012
model	OV504535L	OV555040L
sizes of head, cm	50×45	55×50
material of head	aluminum	aluminum
material of mesh	nylon line	nylon line
sizes of cells, mm	7×7	7×7
depth of net, cm	45	45
color of mesh	clear	clear
weight, g	130	150

### LANDING NET HEAD



code	6633002	6633006
model	OV-504030-L7×8	OV-554540-L20×20
sizes of head, cm	50×40	55×45
material of head	aluminum	aluminum
material of mesh	nylon line	nylon line
sizes of cells, mm	7×8	20×20
depth of net, cm	30	40
color of mesh	black	black

## LANDING NET HEADS



### LANDING NET HEAD

code	6633005
model	OV554535-P6*6
sizes of head, cm	55*45
material of head	aluminum
material of mesh	rubber
sizes of cells, mm	6*6
depth of net, cm	35
color of mesh	black

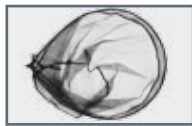

### LANDING NET HEAD

code	6633003
model	OV504025-R
sizes of head, cm	50*40
material of head	aluminum
material of mesh	silicone
sizes of cells, mm	15*15
depth of net, cm	25
color of mesh	clear



### REPLACEMENT NET AREA 404020-R



code	1633300
diameter, cm	40
depth, cm	20
material	silicone

### REPLACEMENT NET

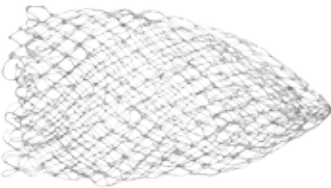

code	1620715	1620716	1620717	1620718
diameter, cm	50	60	70	80
material	capron	capron	capron	capron

### REPLACEMENT NET

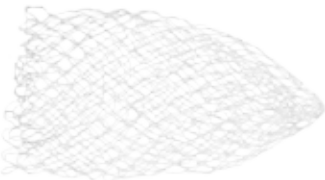

code	1620725	1620726	1620727	1620728
diameter, cm	50	60	70	80
material	nylon line	nylon line	nylon line	nylon line

### NET FLOAT



code	1630031
dimensions, cm	15*5





ROD COVER **SINTEZ 4 ROD HOLDALL**

code	material	length, cm	width, cm	depth, cm	number of sections
7039000	PVC	160	23	28	2



**EVA FEEDER BAG**



code	material	thickness of material, mm	dimensions, cm
7139005	EVA	0.8	38×23×31

- 4 plastic boxes included, sizes of boxes 36×22×5 cm, with removable dividers



## FEEDER ACCESSORY BAG



code	material	dimensions, cm
7139028	PVC	46×33×22

- 4 outside pockets on all sides and one big pocket on the lid
- strengthened bottom
- 2 cases with zipper included
- removable divider which splits main compartment into 2 parts



SCAN ME

## ACCESSORY CASE 6 L

code	material	dimensions, cm
7139200	EVA with 0.8 mm thickness	30×20×10



SCAN ME



## STORAGE SYSTEM BAIT COMPACT

code	material	dimensions, cm
1339101	EVA with 0.8 mm thickness	27×17×8



SCAN ME



## ACCESSORY CASES

code	material	dimensions, cm
1339100	EVA with 0.8 mm thickness	21×14.5×8 (1)
		24×15.5×9 (2)
		27×17×10 (3)



SCAN ME



## BAIT STORAGE SYSTEM

code	material	dimensions, cm
1339102	EVA with 0.8 mm thickness	38×27×10
		9×12×9.5 (2 pcs)
		19×13×9.5 (1 pcs)
		17×26×9.5 (1 pcs)



SCAN ME



**CARRYALL 55 L**

code	material	dimensions, cm
7139025	PVC	62×38×43



**KEEPNET BAG**

code	material	dimensions, cm
7139020	EVA with 1.0 mm thickness	60×13×54



**GROUNDBAIT BOWL**

code	material	dimensions, cm
1339000	EVA with 1.0 mm thickness	diameter - 30 height - 20

- volume - 14 l



**WATER BUCKET**

code	material	dimensions, cm
1339005	EVA with 1.0 mm thickness	18×18×18

- length of rope - 4 m
- volume - 5.8 l



**EVA COOL BAG**



code	material	dimensions, cm
7139100	EVA with 0.8 mm thickness	42×22×23

- thickness of thermal insulation layer - 8 mm

### NEW AB-1007SS

code	material	dimensions, cm
1339200	plastic	10.7*73*30



### NEW AB-1310SD

code	material	dimensions, cm
1339202	plastic	13.2*97*33



### NEW AB-1310SS

code	material	dimensions, cm
1339201	plastic	13.2*97*33



### NEW RWC-1710

code	material	dimensions, cm
1339209	plastic	17.5*10.5*38



### NEW RWC-1710F

code	material	dimensions, cm
1339208	plastic	17.5*10.5*38



### NEW LC-2015

code	material	dimensions, cm
1339205	plastic	20.5*15.5*33



### NEW LC-2015F

code	material	dimensions, cm
1339206	plastic	20.5*15.5*33



**WC-2015 M**

**NEW**

code	material	dimensions, cm
1339210	plastic	20.5×15.5×33



**WC-2520 L**

**NEW**

code	material	dimensions, cm
1339211	plastic	25.5×19.5×33



**LC-2718**

**NEW**

code	material	dimensions, cm
1339207	plastic	27.5×18.3×45



**GC REVERSIBLE BOXES**

code	model	number of sections	dimensions, cm
1330050	14510	10	20.6×17.5×4.4
1330051	16514	14	27.5×18.7×5
1330052	19518	19	34.5×22×5.2



**BAIT BOX**



code	size	material	dimensions, cm
1339500	S	plastic	17.5×17.5×5
1339501	M	plastic	17.5×17.5×6.5
1339502	L	plastic	17.5×17.5×10

- for livebaits

code	size	material	dimensions, cm
1339505	L	plastic	17.5×17.5×10

- for stick-mix

### STIFF RIG WALLET 29\*14

code	material	dimensions, cm
7134203	PVC	29*14*4



### STIFF RIG WALLET 35\*14

code	material	dimensions, cm
7134813	PVC	35*14*4



### RIG CASE SYSTEM

code	material	dimensions, cm
1330001	plastic	34.4*9.5*4.7

- can fit – 30 leaders with max. length 25 cm



### ACCESSORY / REEL BAG

code	material	dimensions, cm
7130067	PVC	27*29*12



### REEL BAG

code	material	dimensions, cm
7130066	PVC	20*19*17

- 2 sections



### REEL BAG

code	material	dimensions, cm
7134819	PVC	21*16*11



BAIT BUCKET **25\*22**

code	material	dimensions, cm
7130015	polyester 840D	diameter - 25 height - 22



BAIT BUCKET

code	material	dimensions, cm
7134815	PVC	diameter - 30 height - 17



BAIT KEEPER BUCKET

code	material	dimensions, cm
7134811	PVC	diameter - 25 height - 21



SAFETY CARP SACK

code	material	dimensions, cm
7139022	PVC	120x100

- with zipper
- cover bag included



**MIRROX BAKKAN** **NEW**

code	model	material	dimensions, cm
7139310	M	EVA with 2 mm thickness	36x24x26
7139311	L	EVA with 2 mm thickness	41x26x27
7139312	XL	EVA with 2 mm thickness	47x29x28

- number of rod holders – 2 pcs



**BAKKAN ROD STAND** **NEW**

code	model	material	dimensions, cm
7139300	M	plastic	xx
7139311	L	plastic	xx
7139312	XL	plastic	xx



### ROD STAND BAKKAN BAG

code	model	material	dimensions, cm
7139305	M	EVA with 2 mm thickness	36×24×26
7139306	L	EVA with 2 mm thickness	41×26×27
7139307	XL	EVA with 2 mm thickness	47×29×28

- number of rod holders – 2 pcs



SCAN ME



### BAG BAKKAN

code	model	material	dimensions, cm
7134000	BB-3020E	EVA	30×20×20
7134001	BB-3522E	EVA	35×22×22
7134002	BB-4025E	EVA	40×25×25
7134003	BB-4528E	EVA	45×28×28

- spring-loaded sashes of window for fish



### BACKPACK ONE SHOULDER BAG

code	material	dimensions, cm
7230009	PVC 600D	25×10×57

- retriever included
- volume – 10 l



SCAN ME



### SLING BAG

code	material	dimensions, cm
7139030	PVC 840D	34×24×12

- 2 plastic boxes with sizes 27.5×18×4 cm included



SCAN ME



### HIP BAG

code	material	dimensions, cm
7139041	PVC 840D	30×15×19

- waist bag



SCAN ME



### SPINNING VEST

code	2630003
------	---------

- adjustable size
- 11 roomy pockets





ACCESSORY BAG

code	material	dimensions, cm
7134818	PVC 600D	32×24×15



SPINNING BAG (4 BOXES)

code	material	dimensions, cm
7130011	PVC 600D	29×20×20

- 4 plastic boxes included:  
 sizes 27.5×18×4.2 cm – 3 pcs  
 sizes 23×12×4.2 cm – 1 pcs



TRAVEL DUFFLE BAG

code	material	dimensions, cm
7139032	oxford 600D	36×36×60

- volume – 60 l
- color – black



WP DUFFLE BAG

code	material	dimensions, cm
7139035	PE 840D	62×52×38

- WP – Waterproof
- model L
- color – black



BOOTS BAG



The bag is intended for carrying/storing dirty and wet shoes.

Made of light, durable and waterproof material, thanks to which even very wet and dirty shoes can be placed inside.

The bag is easy to clean under running water.

It will perfectly fit other belongings necessary for hunting or fishing (gloves, knee pads, hats, etc.).

code	material	dimensions, cm
7139090	PVC tent, PVC 300D PE	30×45×38

- color – black

### CITY BACKPACK

code	material	dimensions, cm
7239000	PVC 840D	32×50×15

- volume - 24 l



### MIRROX BACKPACK

code	material	dimensions, cm
7239001	PVC 840D	33×46×23

- volume - 30 l



### GREEN BACKPACK

code	material	dimensions, cm
7230001	PVC 600D	38×60×28

- volume - 50 l



### COOL BAG

code	material	dimensions, cm	volume, l
7139104	PVC 840D	32×19×23	12
7139105	PVC 840D	36×25×28	20
7139106	PVC 840D	41×26×30	28



### TUBE GOLDEN CATCH

code	material	length, cm	diameter, cm
7034840	PVC 600D	118	8.5
7034806	PVC 600D	135	8.5



### COMPACT CAMPING COT



SCAN ME

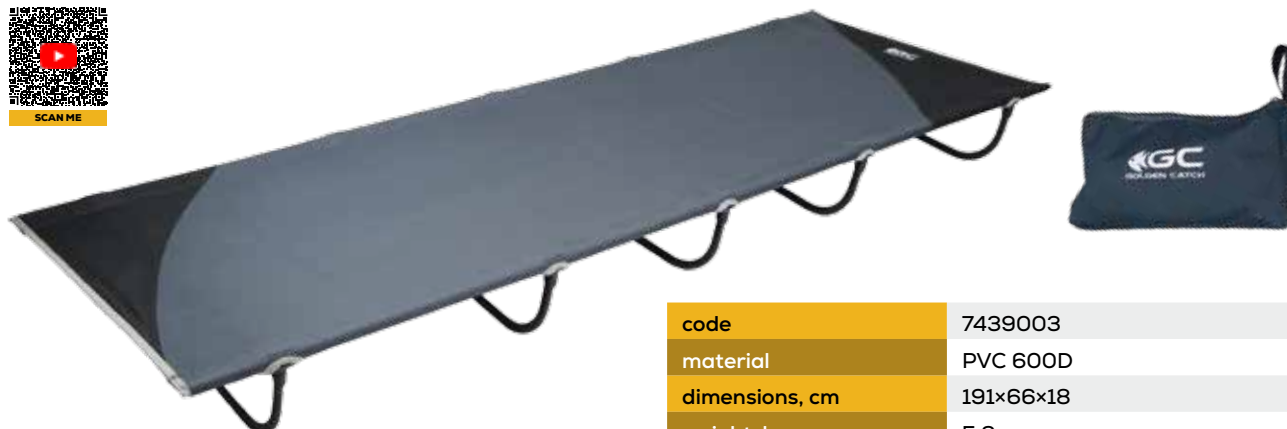

code	7439003
material	PVC 600D
dimensions, cm	191×66×18
weight, kg	5.2
max load, kg	120

- frame – steel tube d = 16 mm,  
leg profile – 17×10 mm
- folded – 45×25×10 cm

### 3 SEASON SLEEPING BAG



code	7634207
dimensions, cm	215×95
outer material	190T Polyester
inner material	polar 50 breathable
filling	350 g/m <sup>2</sup> sintepon

- double-sided powerful zipper



### CHAIR WITH FOLDING SIDE TABLE



code	7439025
material	PVC 600D
dimensions, cm	52×39×49
height of back, cm	92.5
weight, kg	6.48

- profile – steel tube d = 25 mm
- folding side table
- cover with handles included

### CHAIR (7 ADJUST ANGLES)



code	7439016
material	polypropylene
dimensions, cm	48.5×42×48
height of back, cm	119
weight, kg	5.4

- profile – aluminum d = 22/25 mm
- 7 back adjust angles

### CHAIR (5 ADJUST ANGLES)



code	7434740
material	PVC 600D
dimensions, cm	60×60×60
height of back, cm	100
weight, kg	4.66

- profile – aluminum tube d = 19/25 mm
- 5 back adjust angles

## CHAIR WITH STRENGTHENED ARMRESTS



code	7434742
material	PVC 600D
dimensions, cm	60×55×35
height of back, cm	93
weight, kg	4.9

- profile – steel tube d = 16/20 mm
- strengthened armrests
- cover with handles included

## CAMPING FOLDING CHAIR



code	7434716
material	PVC 600D
dimensions, cm	50×48×37
height of back, cm	80
weight, kg	3.15

- profile – steel tube d = 16 mm
- soft armrests
- cover with handles included

### PORTABLE CHAIR



code	7534701	7533111
material	PVC 600D	PVC 600D
dimensions, cm	18.5×39×35	18×30×28
model	L	S
weight, kg	1.45	1.3

- cover with handles included

### CAMPING TABLE



code	7339002
material	PVC 600D
dimensions, cm	80×60×78

- profile – aluminum tube  
d = 16/25 mm
- cover with handles included



### FOLDABLE TABLE (SET)



code	7339000
material of chairs	PVC 600D
dimensions, cm	120×60×70

- profile – aluminum tube  
d = 19/22/25 mm
- hole for umbrella in the middle of the table
- 4 chairs and cover included



## CASABLANCA-4



code 7730131

- Outer material – 210T PU polyester, hydrostatic head 3000 mm
- Inner material – 190T breathable polyester
- Profile – aluminum tubes d = 11 mm
- Floor – polyethylene 10×10 PE
- Sewn-in bottom provides good water resistance
- Insect mesh door

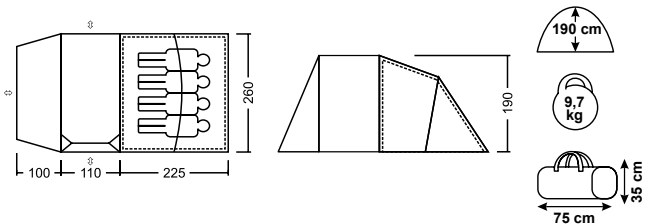

## SOFIA-4



code 7730133

- Outer material – 68D 190T PU polyester, hydrostatic head 2500 mm
- Inner material – 68D 190T breathable polyester
- Profile – fiberglass tubes d = 9.5/11 mm
- Floor – polyethylene 10×10 PE
- Insect mesh windows
- Insect mesh door

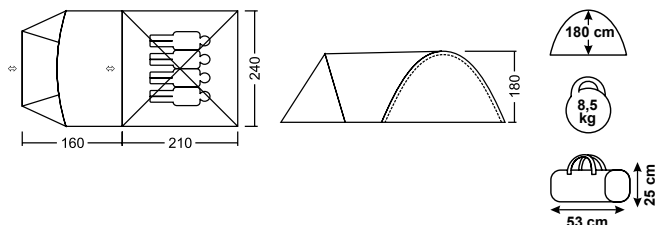

## SCREEN DINING LUKSOR



code 7730101

- Material of ceiling part – 68D 190T PU polyester, hydrostatic head 1500 mm
- Material of walls – insect mesh + 68D 190T PU polyester
- Profile – fiberglass tubes d = 9.5 mm, steel d = 19 mm
- 3 entrances

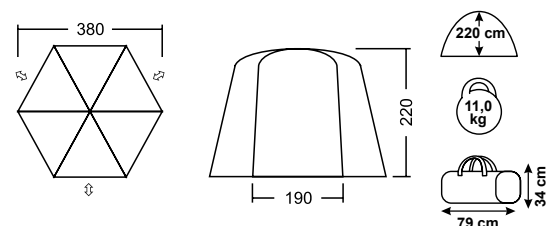

UMBRELLA **SINTEZ**



code	7739005
model	Flat Back Brolly 250
diameter, cm	250
canopy material	1200D polyester PU2000
rib material	fiberglass
pole material	aluminum

- 2 pegs and cover included





UMBRELLA SHELTER



code	7739000
diameter, cm	250
weight, kg	4.2
canopy material	190D polyester PU1500
material of walls	taffeta 66D / insect mesh
rib material	metal
pole material	aluminum

- cover included



VACUUM FLASK **MURRAY**

code	6139005	6139006
inner wall	stainless steel	
outer wall	stainless steel	
thermal insulation, °C	0 hours	> 98 °C
	6 hours	> 84 °C
	12 hours	> 77 °C
	24 hours	> 64 °C
volume, l	1.5	2.0

VACUUM FLASK **HEIZ**

code	6139000	6139001	6139002
inner wall	stainless steel		
outer wall	stainless steel		
thermal insulation, °C	0 hours	> 98 °C	> 98 °C
	6 hours	> 80 °C	> 82 °C
	12 hours	> 72 °C	> 74 °C
	24 hours	> 58 °C	> 60 °C
volume, l	0.5	0.75	1.0



### HEADLIGHT FV201 W/UV SENSOR WITH CLIP



code 8539002

- 2 types of LED – white and UV, white LED has 3 levels of brightness
- maximum brightness – 110 lumens
- type of battery: lithium polymer (3.7V/500 mAh (built in))
- 4 lighting modes
- switch type: push on / off switch
- run time: 4 hours on maximum brightness
- waterproof: IPX5
- with motion sensor
- distance of flashlight: 7 m
- elastic headband and Type-C cable included
- weight: 33 grams
- color: black



### ROD BELT RB-02N SIZE M



code	dimensions, mm	thickness, mm	color
1620301	210×20	3	grey

- material – neoprene
- 2 pcs/pack

### FLEXIBLE ROD PROTECTOR



code	length, cm	color
7020306	81-130	grey

- material – neoprene

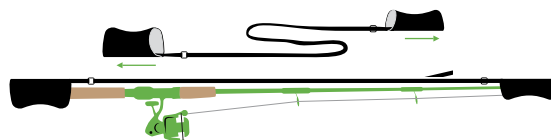

### NEOPRENE REEL COVER



code	dimensions, mm	material thickness, mm	reels size
7020310	150×140×40	5	1000-2500
7020311	160×150×45	5	3000-4000

- material – neoprene

**FISHING TOWEL**

code	dimensions, cm	color
1639905	35×25	brown



**FISHING TOWEL WITH POCKET**

code	dimensions, cm	color
1639902	35×18	beige
1639904	35×18	green



**SPRING RETRIEVER**



code	length of spring, cm	max. length, cm
1636260	13	90

- 2 aluminum carabiner snap

**ROD STAND**



code	6733001
can fit rods, pcs	16
dimensions, cm	44×90×21
folded, cm	21×47×12

- compact plastic rod stand
- can be used to showcase and store rods
- the double-sided storage stand stacks 8 rods on each side (16 in total)
- color – black/grey
- material – plastic



SCAN ME

## POLARIZED GOLDEN CATCH



code model  
2920043 Military Black YL



code model  
2920044 Military Camo Green GR



code model  
2920045 Military Camo Green YL



code model  
2920046 Mirrox RR



code model  
2920004 SBK192GR



code model  
2920032 SBL201BLR



code model  
2920047 Sintez BL-F



code model  
2920100 Elite AL-MBL001BLR



code model  
2920101 Elite AL-MBK002GR



code model  
2920102 Elite AL-SG003BLR



code model  
2920103 Elite AL-MBK004G



code model  
2920040 MBB171GR



code model  
2920033 MBL1111WHM



code model  
2920034 MG1211BR



code model  
2920039 MW512BLR



code model  
2920030 SB912BLR



code model  
2920025 SB511BLR



code model  
2920026 SB512BR



code model  
2920031 SB513YE



code model  
2920029 MG911BR



code model  
2920038 SB1621GG

**POLARIZED GOLDEN CATCH**



code	model
2920021	MB621GR



code	model
2920022	MB622BR



code	model
2920020	MG232BR



code	model
2920024	MG221BLR



code	model
2920027	SB731GRR



code	model
2920001	SBF131BR-W

• floating



code	model
2920002	MB821BLR-F

• floating



code	model
2920003	MB822BR-F

• floating



code	model
2920037	MBC1521GRR-F

• floating



code	model
2920036	MB1421BRL-F

• floating



code	model
2920035	MB1321WHM-F

• floating



code	model
2920028	MB332BLR



code	model
2920023	MCG331GR



code	model
2920005	MBC401BR Cap Clip-on

**SUNGLASSES ACCESSORIES**



code	model
1620106	hard case "Elite"



code	model
1620105	hard case



code	model
1620100	velour case



code	model
1620110	strap

### TIP GUIDE **BKGTST** BLACK

code	inner ring, mm	rod fitting, mm
2139000	5	1.4
2139001	5	1.6
2139002	5	1.8
2139003	5	2.0
2139004	5	2.2
2139005	6	1.6
2139006	6	1.8
2139007	6	2.0
2139008	6	2.2
2139009	6	2.4
2139010	8	2.0
2139011	8	2.2
2139012	8	2.4
2139013	8	2.6
2139014	8	2.8

- 10 pcs/pack



### TIP GUIDE **GSULTST** GUN SMOKE

code	inner ring, mm	rod fitting, mm
2139060	5	0.8
2139061	5	1.0
2139062	5	1.2
2139063	5	1.4
2139064	5	1.6
2139065	5	1.8
2139066	5	2.0

- 10 pcs/pack



### GUIDE **BSMTSG** BLACK

code	inner ring, mm	rod fitting, mm
2139200	6	2.2
2139201	6	2.4
2139202	6	2.6
2139203	6	2.8
2139204	6	3.0
2139205	6	3.2
2139206	6	3.4
2139207	6	3.6

- sliding
- 10 pcs/pack



### TIP GUIDE **BMKTST** BLACK

code	inner ring, mm	rod fitting, mm
2139020	4	1.0
2139021	4	1.2
2139022	4	1.4
2139023	5	1.0
2139024	5	1.2
2139025	5	1.4
2139026	5	1.6
2139027	5	1.8
2139028	6	1.2
2139029	6	1.4
2139030	6	1.6
2139031	6	1.8

- 10 pcs/pack



### GUIDE **BMKTSG** BLACK

code	inner ring, mm	pcs/pack
2139240	4	10
2139241	5	10
2139242	6	10
2139243	8	10



GUIDE **BKLLSG** BLACK

code	inner ring, mm	pcs/pack
2139210	12	10
2139211	16	10
2139212	20	5
2139213	25	5



GUIDE **KLLSG** CHROME

code	inner ring, mm	pcs/pack
2139215	12	10
2139216	16	10
2139217	20	5
2139218	25	5



GUIDE **BKTLSG** BLACK

code	inner ring, mm	pcs/pack
2139220	3	10
2139221	4	10
2139222	5	10
2139223	6	10
2139224	8	10
2139225	10	10



GUIDE **KTLSG** CHROME

code	inner ring, mm	pcs/pack
2139230	3	10
2139231	4	10
2139232	5	10
2139233	6	10
2139234	8	10
2139235	10	10



GUIDE **BKWLSG** BLACK

code	inner ring, mm	pcs/pack
2139400	6	10
2139401	8	10
2139402	10	10
2139403	12	10
2139404	16	10
2139405	20	5
2139406	25	5
2139407	30	5



GUIDE **KWLSG** CHROME

code	inner ring, mm	pcs/pack
2139410	6	10
2139411	8	10
2139412	10	10
2139413	12	10
2139414	16	10
2139415	20	5
2139416	25	5
2139417	30	5



**NEW**

**GLOVES TITANIUM 3 CUT TR-303**

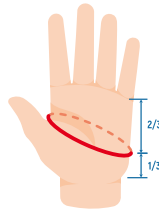

code	size	palm size, cm
2639920	M	22-23
2639921	L	23-24
2639922	XL	24-25
2639923	XXL	25-27

**NEW**

**GLOVES TITANIUM 5 CUT TR-305**

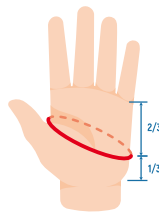

code	size	palm size, cm
2639955	M	22-23
2639956	L	23-24
2639957	XL	24-25
2639958	XXL	25-27

**GLOVES SUNGLOVE 5 CUT PN-101**

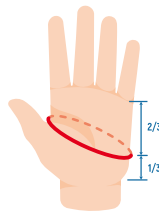

code	size	palm size, cm
2639990	S	19-20
2639991	M	20.5-22
2639992	L	22-23.5
2639993	XL	23.5-25

**GLOVES 5 CUT MR-201**

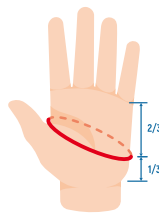

code	size	palm size, cm
2639950	M	22-23
2639951	L	23-24
2639952	XL	24-25
2639953	XXL	25-27

**GLOVES 3 CUT SR-201**

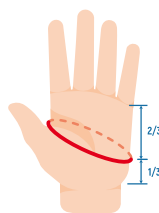

code	size	palm size, cm
2639900	M	22-23
2639901	L	23-24
2639902	XL	24-25
2639903	XXL	25-27



GLOVES **TITANIUM 3 CUT FINGERTIP TR-301**

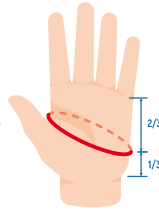

code	size	palm size, cm
2639910	M	22-23
2639911	L	23-24
2639912	XL	24-25
2639913	XXL	25-27

GLOVES **TITANIUM 3 CUT TW-301**

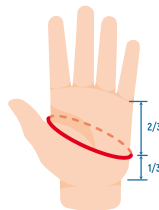

code	size	palm size, cm
2639905	M	22-23
2639906	L	23-24
2639907	XL	24-25
2639908	XXL	25-27

CAP **SPORT BLACK**



code	size
2839100	56-59

- cotton - 50%
- polyester - 50%

CAP **TRUCKER BLACK WITH MESH**



code	size
2839101	56-59

- cotton - 50%
- polyester - 50%

CAP **GREY**



code	size
2839001	

CAP **BLUE WITH MESH**



code	size
2839000	

**JERSEY FIRE ZANDER-PERCH CM106**



code	size	width, cm	height, cm	sleeve length, cm
2639080	S	51	72	77
2639081	M	53	74	78
2639082	L	57	76	79
2639083	XL	59	79	80
2639084	XXL	62	82	81
2639085	XXXL	66	85	82

- material – 100% polyester
- sun protection UPF +50



**JERSEY FIRE CARP-BREAM CM105**



code	size	width, cm	height, cm	sleeve length, cm
2639070	S	51	72	77
2639071	M	53	74	78
2639072	L	57	76	79
2639073	XL	59	79	80
2639074	XXL	62	82	81
2639075	XXXL	66	85	82

- material – 100% polyester
- sun protection UPF +50



**JERSEY FIRE CM104**

code	size	width, cm	height, cm	sleeve length, cm
2639060	S	51	72	77
2639061	M	53	74	78
2639062	L	57	76	79
2639063	XL	59	79	80
2639064	XXL	62	82	81
2639065	XXXL	66	85	82

- material – 100% polyester
- sun protection UPF +50

**JERSEY CARP-BREAM CM103**

code	size	width, cm	height, cm	sleeve length, cm
2639000	S	51	72	77
2639001	M	53	74	78
2639002	L	57	76	79
2639003	XL	59	79	80
2639004	XXL	62	82	81
2639005	XXXL	66	85	82

- material – 100% polyester
- sun protection UPF +50





GOLDEN CATCH®

**G.C. CARP**  
**TACKLE BOX**

MINI BOX TWO LAYER

12 SECTIONS

KHAKI

SIZES: 10.2\*8.8\*2.4 cm



EATCH®

**ARP**  
**OX**

AYER

8 SECTIONS  
KHAKI

SIZES: 10.2\*8.8\*2.4 cm



GOLDEN C

**G.C. CARP**  
**TACKLE B**

MINI BOX

SIZES

GOLDEN CATCH  
G.C. CARP

G.C. CARP

GOLDEN CATCH  
G.C. CARP

G.C. CARP

GOLDEN CATCH  
G.C. CARP

G.C. CARP



# G.CARP

The idea of developing premium quality products for carp fishing has been around for a long time. Our task was not only to make this line of products of high quality, but also to get a more affordable, competitive price for the end consumer. And at this stage, we succeeded. After more than 3 years of development and testing, the first products of the G.Carp line appeared on the shelves.

The accessories are already on sale – hooks, leader materials, shock leaders, needles, and various “terminals” for making rigs and leaders. Ready-made leaders, PVA materials, leader holders, etc. also available for purchase.

And as for our future plans, in addition to the expansion of various accessories, we are going to make PVA materials, devices that facilitate carp fishing, rods, reels, bags and covers for transportation and storage of equipment, tents and camping furniture, and much more.

**NEW**

## SUPER BRAID SOFT FLAT X4



Weed Green	length, m	test, kg	test, lb
4165210	50	6.8	15
4165211	50	11.3	25
4165212	50	15.9	35

- without coating

**NEW**

## STRONG BRAID HOOKLINK X6



Dark Green	length, m	test, kg	test, lb
4165205	20	6.3	15
4165206	20	9.1	20
4165207	20	11.3	25

- without coating

## COATED BRAID SOFT



Weed Green	Brown	length, m	test, kg	test, lb
4165230	4165225	20	6.8	15
4165231	4165226	20	11.3	25
4165232	4165227	20	15.9	35

- with coating

## COATED BRAID SEMI-STIFF



Weed Green	Brown	length, m	test, kg	test, lb
4165220	4165215	20	6.8	15
4165221	4165216	20	11.3	25
4165222	4165217	20	15.9	35

- with coating

## COATED BRAID STIFF

**NEW**



Weed Green	Brown	length, m	test, kg	test, lb
4165240	4165235	20	6.8	15
4165241	4165236	20	11.3	25
4165242	4165237	20	15.9	35

- with coating

## LEADCORE

code	length, m	test, lb
4165000	10	50

- color – camouflaged green
- without lead



## TAPERED LEADER

code	length, m	diameter, mm
4065000	5×15	0.26-0.57



## BAIT FLOSS

**NEW**

code	length, m	color
1665050	30	white



## FLOSS CAPS

**NEW**



code	pcs/pack
1665075	24

- color – clear

## MARKER ELASTIC

**NEW**



code	length, m	color
1665445	5	green
1665446	5	orange

## HOOK CHOD & ZIG



code	size	pcs/pack
5565000	8	10
5565001	6	10
5565002	4	10
5565003	2	10

- coating - teflon

## HOOK CURVE SHANK



code	size	pcs/pack
5565005	8	10
5565006	6	10
5565007	4	10
5565008	2	10

- coating - teflon

## HOOK KRANK



code	size	pcs/pack
5565010	8	10
5565011	6	10
5565012	4	10
5565013	2	10

- coating - teflon

## HOOK WIDE GAPE



code	size	pcs/pack
5565015	8	10
5565016	6	10
5565017	4	10
5565018	2	10

- coating - teflon

## HOOK V-CLAW



code	size	pcs/pack
5565020	8	10
5565021	6	10
5565022	4	10
5565023	2	10

- coating - teflon





## READY LEADERS

NEW

### CHOD READY RIG

code	hook, N°	test, lb	hair length
4265033	2	25	4
4265032	4	25	4
4265031	6	25	4
4265030	8	25	4

- hard mono material
- 3 pcs/pack



### METHOD WIDE GAPE READY RIG

code	hook, N°	test, lb	length, mm	hair length
4265007	4	25	10	10
4265006	6	25	10	10
4265005	8	15	10	10

- without coating
- 2 pcs/pack



### BLOW BACK READY RIG

code	hook, N°	test, lb	length, mm	hair length
4265018	2	25	18	20
4265017	4	25	18	20
4265016	6	25	18	16
4265015	8	20	18	16

- with coating
- 1 pcs/pack



### V-CLAW READY RIG

code	hook, N°	test, lb	length, mm	hair length
4265023	2	35	18	20
4265022	4	25	18	20
4265021	6	25	18	16
4265020	8	15	18	16

- with coating
- 1 pcs/pack



### KRANK READY RIG

code	hook, N°	test, lb	length, mm	hair length
4265028	2	35	18	20
4265027	4	25	18	20
4265026	6	25	18	16
4265025	8	15	18	16

- with coating
- 1 pcs/pack



### BRAID X6 WIDE GAPE READY RIG

code	hook, N°	test, lb	length, mm	hair length
4265013	2	25	18	20
4265012	4	25	18	20
4265011	6	25	18	16
4265010	8	20	18	16

- without coating
- 1 pcs/pack



## BAIT STOPS



code	pcs/pack	color
1665499	10	khaki

## HOOK RING STOPS



code	size	pcs/pack
1665500	S	20
1665501	M	20

- color – khaki

## CHOD/HELI BUFFER



code	pcs/pack
1665055	10

- color – khaki

## POWER LEAD CLIP



code	pcs/pack
1665016	5

- color – khaki

## SAFETY LEAD CLIP

### LEAD CLIP WITH QUICK CHANGE



code	pcs/pack
1665017	5

- color – khaki

### LEAD CLIP WITH STOPS



code	pcs/pack
1665018	5

- color – khaki

## ANTI TANGLE SLEEVES



code	length, mm	pcs/pack
1665020	20	10

- color – khaki

## NAKED LINE TAIL RUBBERS



code	length, mm	pcs/pack
1665021	38	10

- color – khaki

## ZIG RIG ANTI TANGLE SLEEVES

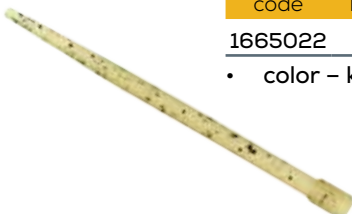

code	length, mm	pcs/pack
1665022	60	10

- color – khaki

## D-RIG KICKERS

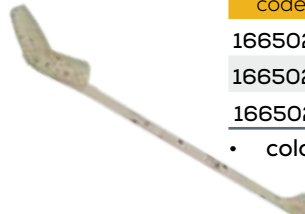

code	size	pcs/pack
1665025	S	10
1665026	M	10
1665027	L	10

- color – khaki

## HOOK KICKERS



code	size	pcs/pack
1665030	S	10
1665031	M	10
1665032	L	10

- color – khaki

## SEMI FIXED RING BUFFER & RING



code	pcs/pack
1665040	10

- color – khaki

## LINE CLIP



code	pcs/pack
1665015	2

- for fixing the line
- color – black

## COATED BRAID STRIPPER



code	pcs/pack
1665390	2 in 1

## MULTI KNOT TOOL 4 IN 1



code	pcs/pack
1665355	

## HAIR GAUGE

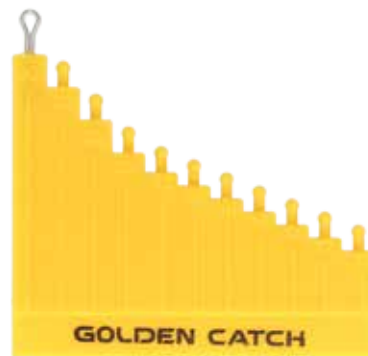

code	pcs/pack
1665385	

## BAITING NEEDLE



code	pcs/pack
1665307	

- length – 55 mm

## BOILIE NEEDLE



code	pcs/pack
1665305	

- length – 55 mm

## SPLICING NEEDLE



code	pcs/pack
1665308	

- length – 55 mm

## STRINGER NEEDLE

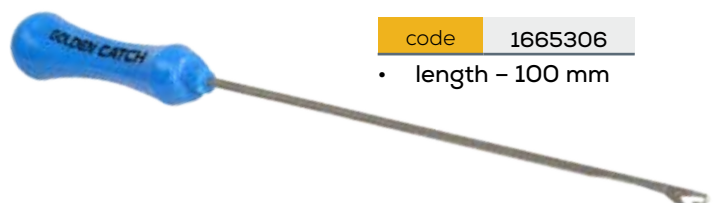

code	pcs/pack
1665306	

- length – 100 mm

## BAIT DRILL & CORKS



code	dia, mm	cork, pcs.
1665072	6	4
1665073	8	3

- with cork sticks

## CORK STICKS

code	dia, mm	pcs/pack
1665060	6	6
1665061	8	6

- material – cork



## BALANCING & ZIG FOAM

code	dia, mm	pcs/pack
1665065	6	6
1665066	8	6

- floating
- color – black, yellow, red, white



## DISTANCE STICKS



code	size, mm	material
1665100	735×12	aluminum

- three groups of notches for fishing line
- plug for light stick
- adjustable marking tape length 3 and 4 meters with glow elements
- cover included

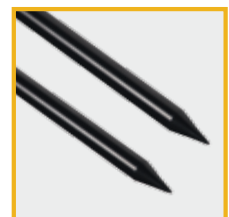
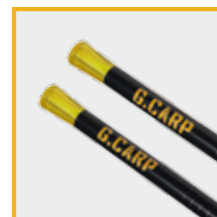
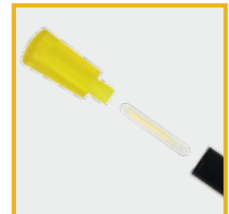
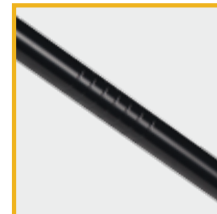

## PVA BAG LOADER KIT

code	3265000
------	---------



## PVA BAIT BAG SYSTEM

code	model	size, mm
3265001	S	55×110
3265002	L	70×160



## PVA STRING



code	length, m
3265005	20

## PVA BAG



code	model	size, mm
3265010	S	55×110
3265011	M	55×140
3265012	L	70×160
3265013	XL	70×190

## SWINGER HI-VIZ BOBBIN

code	6534980	6534981	6534982	6534983	6534984	6534985
color	■ - black	■ - blue	■ - green	■ - violet	■ - red	■ - yellow



## ILLUMINATED STIFF SWINGER

code	6565005	6565006	6565007	6565008
color of LED	■ - yellow	■ - green	■ - red	■ - blue

- metal line clip
- sliding weight on arm
- light indication (electronic)
- plug for connecting to bite alarm



## BUTT ROD REST

code

1665006



## MAGNETIC ROD REST

code

1665005

- magnetic lock reliably holds rod
- maximum diameter of blank – 20 mm



## RIG BOX



code	model	material	dimensions, mm
1365000	MEDIUM	plastic	235×102×35

- the set includes 15 double pins and 30 single pins
- can fit 60 leaders



code	model	material	dimensions, mm
1365001	LARGE	plastic	345×113×36

- the set includes 20 double pins and 30 single pins
- can fit 90 leaders

## DOUBLE PINS



code	pcs/pack	color
1665010	20	yellow

## SINGLE PINS



code	pcs/pack	color
1665011	30	yellow

## SUNGLASSES POLARIZED GRN



code	
2920041	

## FINGER STALL



code	
1639805	

- material – suede



## 1339215 HOOK BOX

NEW

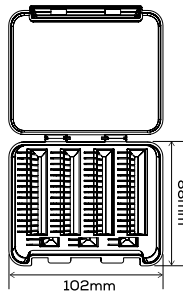
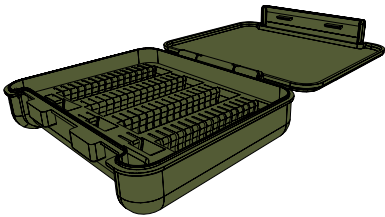

## 1339216 MINI BOX 1

NEW

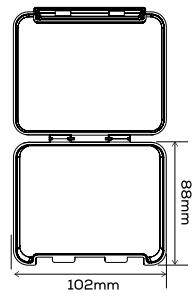
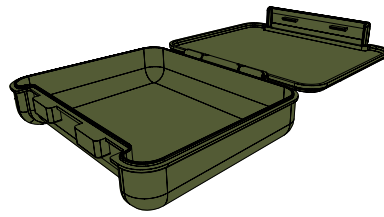

## 1339217 MINI BOX 2

NEW

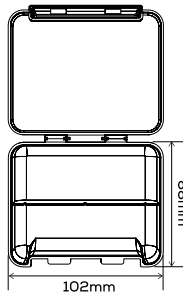
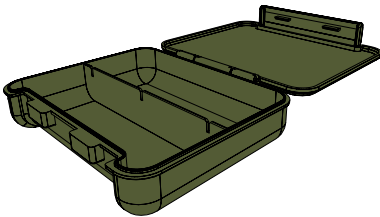

## 1339218 MINI BOX 3

NEW

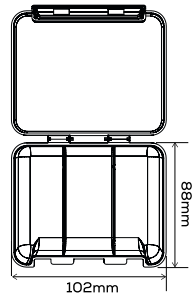
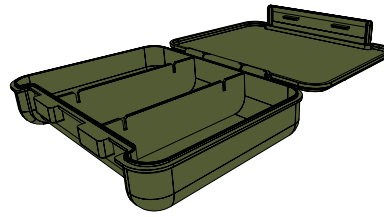

## 1339219 MINI BOX 4

NEW

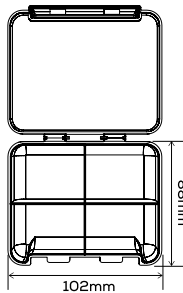
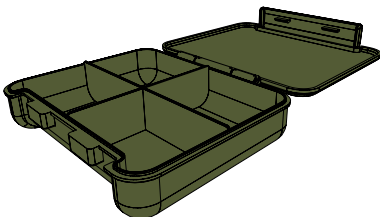

## 1339220 MINI BOX 6

NEW

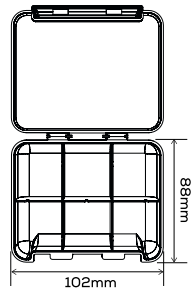
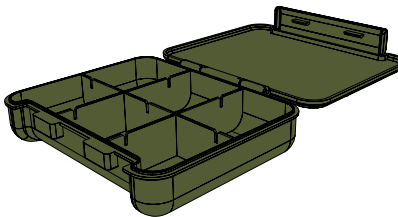

## 1339221 MINI BOX 8

NEW

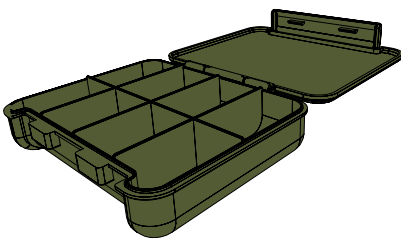

GC G.Carp Mini Box – series of boxes with compartments for various accessories. They are ideal for storing numerous accessories, including swivels, beads, clips, boilie stops, loads, lines, foams, cork sticks, etc.

- Fits perfectly inside Multi Tackle Box XL and Tackle Box L
- Contents remain visible thanks to transparent tinted lids
- Secure locks
- The boxes are available with 1, 2, 3, 4, 6, 8 compartments, as well as 2-tiered boxes with 8 and 12 compartments.

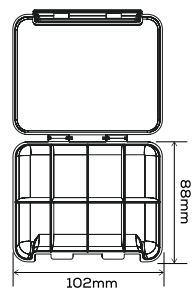

## 1339222 MINI BOX 2 TOP LAYER SECTIONS 6

NEW

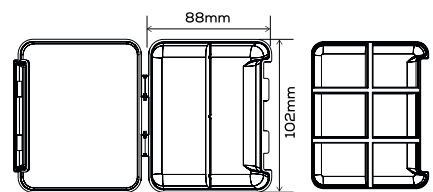
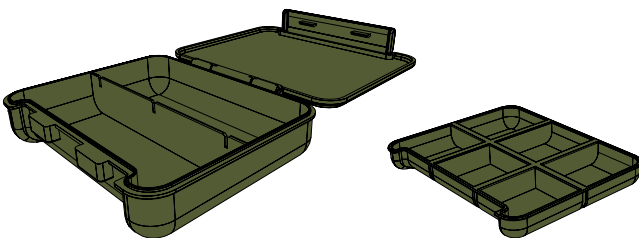

NEW

## 1339223 MINI BOX TWO LAYER SECTION 12

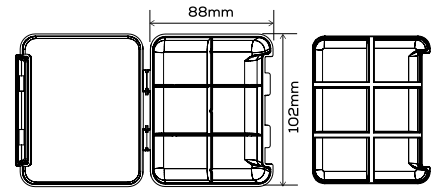
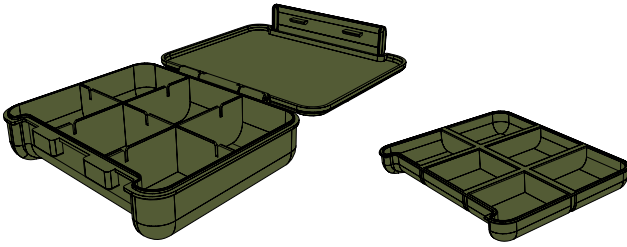

NEW

## 1339224 DEEP TACKLE BOX

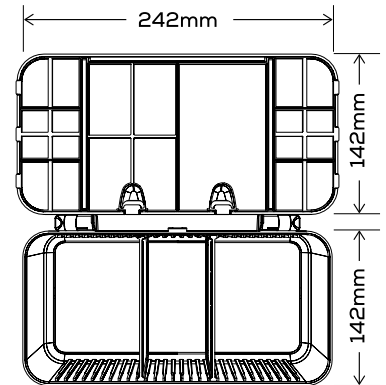
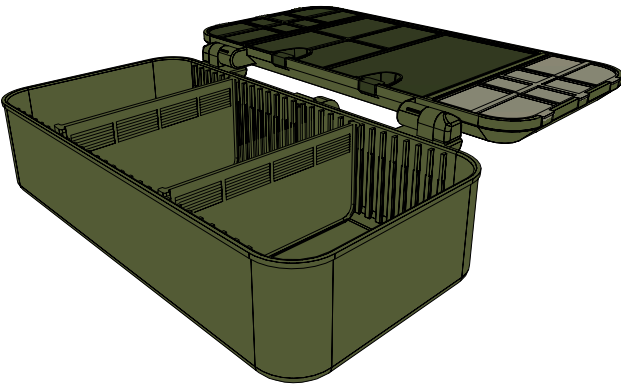

NEW

## 1339225 FLAT TACKLE BOX

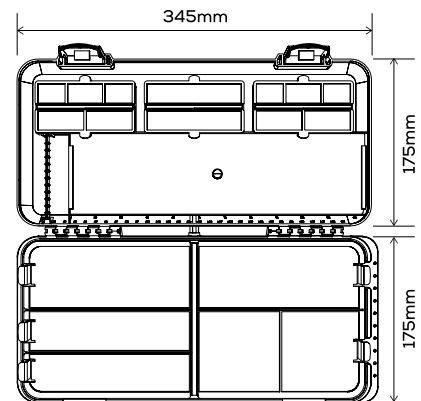
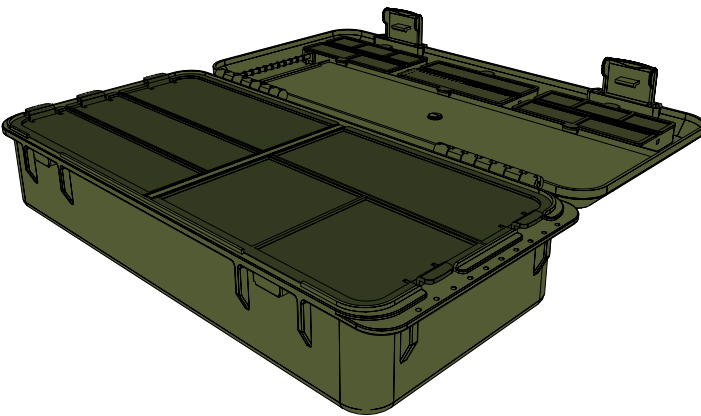

NEW

## 1339228 ACTION STATION

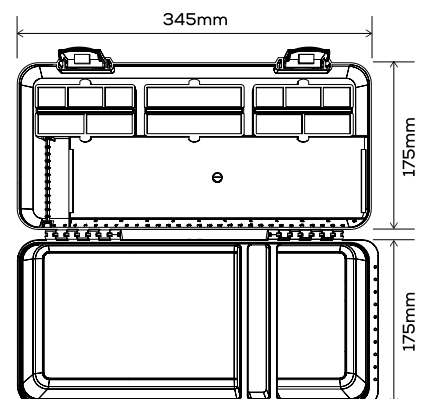
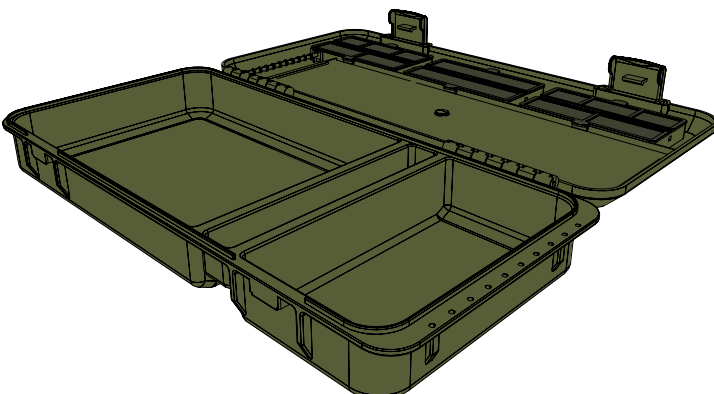

## 1339226 MAJOR TACKLE BOX

NEW

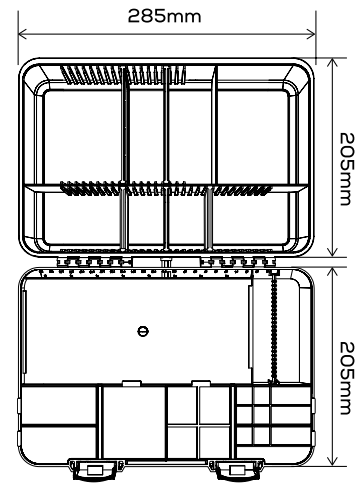
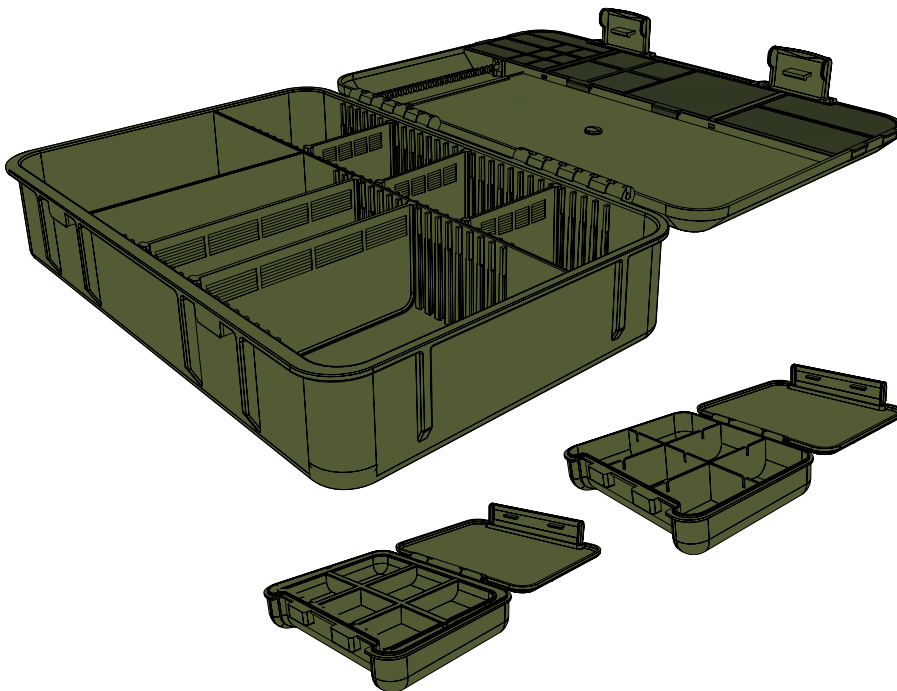

## 1339227 MULTI TACKLE BOX XL

NEW

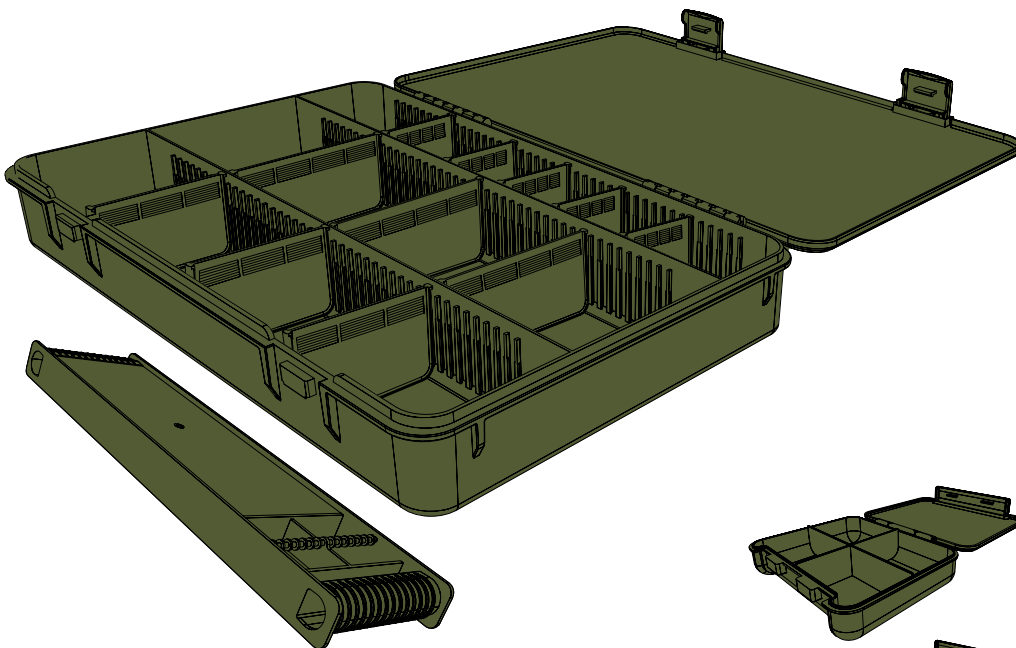

**GC G.Carp Multi Tackle Box XL** – ultimate storage system that allows you to accommodate a large number of tackles for the modern carp angler. With these boxes you will have everything at your hand.

The 14 deep compartments with removable dividers will allow you to place scissors, hooks, leaders, needles, and knitting materials.

The set includes a multifunctional main box, a leader board, as well as 8 mini-boxes with 1, 2, 3, 4, 6, 8 compartments and 2 tiered boxes with 8 and 12 compartments.

G.Carp Deep Tackle Box is weatherproof and long-lasting thanks to its durable ABS-plastic and polypropylene construction. All hinges and locks are very reliable and sturdy. These factors will keep the angler ready for anything.

- Durable ABS and polypropylene construction
- Lid with high-quality locks
- 14 storage compartments
- Leader board
- Pins included
- 8 mini-boxes with 1, 2, 3, 4, 6, 8 compartments and 2 tiered boxes with 8 and 12 compartments.

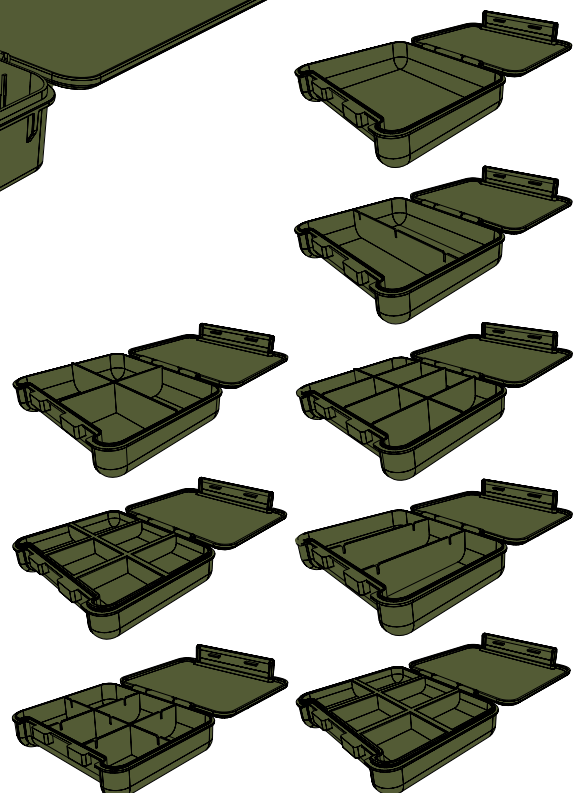



Golden Catch brand has been present on the fishing market for over 20 years. High-quality products and attention to details will not leave any angler indifferent.

The product assortment has everything that a modern fisherman may need – from hooks, reels, rods to sleeping bags, umbrellas and tents. Each product was tested under different conditions and finalized taking into account the latest trends and the needs of anglers.

Best value for money and thoughtful design is why anglers choose Golden Catch.



# MAIN FISHING ELEMENT



**NEW**
**SPECTR SURF**

code	model	length, m	pcs	folded, cm	weight, g	casting, g	material
2010060	SPECTR SURF	3.60	4	118	350	200	glassplastic
2010061	SPECTR SURF	3.90	5	127	475	200	glassplastic
2010062	SPECTR SURF	4.20	5	127	495	200	glassplastic

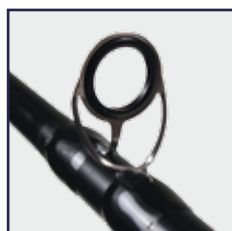
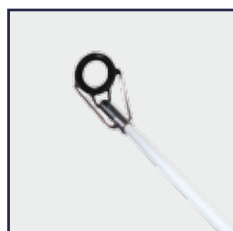
**NEW**
**ELEMENT FEEDER**

code	model	length, m	pcs	folded, cm	weight, g	casting, g	material
2010040	ELEMENT FEEDER	2.40	2+3	126	220	up to 120	glassplastic
2010041	ELEMENT FEEDER	2.70	2+3	141	269	up to 120	glassplastic
2010042	ELEMENT FEEDER	3.00	3+3	107	285	up to 120	glassplastic
2010043	ELEMENT FEEDER	3.30	3+3	117	325	up to 120	glassplastic
2010044	ELEMENT FEEDER	3.60	3+3	127	365	up to 120	glassplastic

- medium action

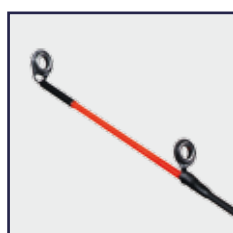

## ELEMENT POWER

NEW

code	model	length, m	pcs	folded, cm	weight, g	casting, g	material
2010045	ELEMENT POWER	2.40	2	127	229	130	glassplastic
2010048	ELEMENT POWER	2.40	2	142	285	160	glassplastic
2010046	ELEMENT POWER	2.70	2	127	229	130	glassplastic
2010049	ELEMENT POWER	2.70	2	142	285	160	glassplastic

- medium fast action



## TOTEM FEEDER

code	model	length, m	pcs	folded, cm	weight, g	casting, g	material
2010320	TOTEM FEEDER	2.7	2+3	138	250	up to 120	glassplastic
2010321	TOTEM FEEDER	3.0	3+3	106	315	up to 120	glassplastic
2010322	TOTEM FEEDER	3.3	3+3	117	336	up to 120	glassplastic
2010323	TOTEM FEEDER	3.6	3+3	124	475	up to 120	glassplastic
2010324	TOTEM FEEDER	3.9	3+3	137	506	up to 120	glassplastic

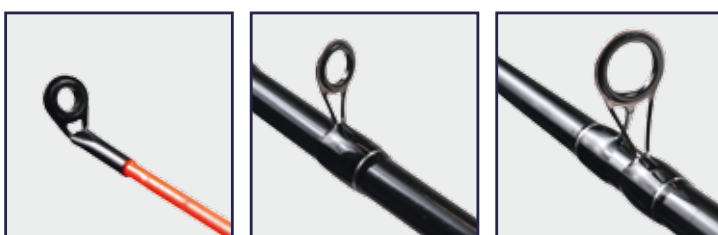

**REVERS CARP**

code	model	length, m	pcs	folded, cm	weight, g	casting, lb	material
2010030	REVERS CARP	3.30	3	119	380	3.75	glassplastic
2010031	REVERS CARP	3.60	3	129	477	3.75	glassplastic
2010032	REVERS CARP	3.90	3	139	500	3.75	glassplastic

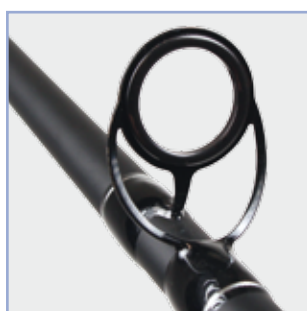
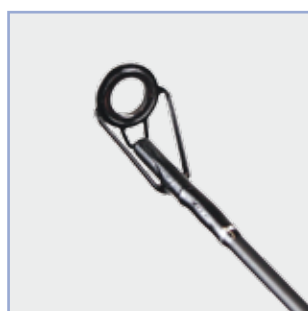
**NEW**
**FACTOR UNIVERSAL**

code	model	length, m	pcs	folded, cm	weight, g	casting, g	material
2010065	FACTOR UNIVERSAL	1.50	3	70	110	120	glassplastic
2010066	FACTOR UNIVERSAL	1.80	4	70	162	120	glassplastic
2010067	FACTOR UNIVERSAL	2.10	5	70	194	120	glassplastic
2010068	FACTOR UNIVERSAL	2.40	5	70	212	120	glassplastic
2010069	FACTOR UNIVERSAL	2.70	6	72	274	120	glassplastic
2010070	FACTOR UNIVERSAL	3.00	6	75	292	120	glassplastic

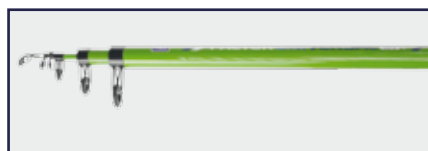



### NETRINO PRO

code	model	length, m	pcs	folded, cm	weight, g	casting, g	material
2010310	NETRINO PRO	2.10	5	66	180	30-100	graphite
2010311	NETRINO PRO	2.40	5	73	195	30-100	graphite
2010312	NETRINO PRO	2.70	6	86	292	40-120	graphite
2010313	NETRINO PRO	3.00	6	87	300	50-140	graphite
2010314	NETRINO PRO	3.60	7	93	390	60-170	graphite



SCAN ME



### NETRINO

code	model	length, m	pcs	folded, cm	weight, g	casting, g	material
2010300	NETRINO	2.10	5	66	185	30-60	graphite
2010301	NETRINO	2.40	5	73	200	40-90	graphite
2010302	NETRINO	2.70	6	86	305	40-90	graphite
2010303	NETRINO	3.00	6	87	320	50-120	graphite
2010304	NETRINO	3.60	7	93	400	60-160	graphite



SCAN ME



**ELEMENT EC TELE**

code	model	length, m	pcs	folded, cm	weight, g	casting, g	material
2010020	ELEMENT EC TELE	1.80	5	48	120	20-100	glassplastic
2010021	ELEMENT EC TELE	2.10	5	55	158	20-100	glassplastic
2010022	ELEMENT EC TELE	2.40	6	56	216	20-100	glassplastic
2010023	ELEMENT EC TELE	2.70	6	58	225	20-100	glassplastic
2010024	ELEMENT EC TELE	3.00	7	59	318	20-100	glassplastic
2010025	ELEMENT EC TELE	3.60	8	69	515	20-100	glassplastic

**ELEMENT EA TELE**

code	model	length, m	pcs	folded, cm	weight, g	casting, g	material
2010000	ELEMENT EA TELE	0.50	2	33	33	-	glassplastic
2010001	ELEMENT EA TELE	0.70	3	33	40	-	glassplastic
2010002	ELEMENT EA TELE	1.00	4	33	64	-	glassplastic
2010003	ELEMENT EA TELE	1.50	5	46	104	20-60	glassplastic
2010004	ELEMENT EA TELE	1.80	5	46	106	20-60	glassplastic
2010005	ELEMENT EA TELE	2.10	6	50	150	20-80	glassplastic
2010006	ELEMENT EA TELE	2.40	6	57	175	20-80	glassplastic
2010007	ELEMENT EA TELE	2.70	6	67	185	20-80	glassplastic
2010008	ELEMENT EA TELE	3.00	7	68	270	20-80	glassplastic
2010009	ELEMENT EA TELE	3.60	8	69	350	20-80	glassplastic



### ELEMENT EX

code	model	length, m	pcs	folded, cm	weight, g	material
2510020	ELEMENT EX bolo	4.0	4	125	171	graphite
2510021	ELEMENT EX bolo	5.0	5	127	248	graphite
2510022	ELEMENT EX bolo	6.0	6	129	357	graphite
2510025	ELEMENT EX pole	4.0	4	121	140	graphite
2510026	ELEMENT EX pole	5.0	5	121	213	graphite
2510027	ELEMENT EX pole	6.0	6	121	312	graphite



### ELEMENT EC

code	model	length, m	pcs	folded, cm	weight, g	material
2510010	ELEMENT EC bolo	4.0	4	119	200	graphite
2510011	ELEMENT EC bolo	5.0	5	119	300	graphite
2510012	ELEMENT EC bolo	6.0	6	119	436	graphite
2510015	ELEMENT EC pole	4.0	4	116	186	graphite
2510016	ELEMENT EC pole	5.0	5	116	287	graphite
2510017	ELEMENT EC pole	6.0	6	116	403	graphite



**ELEMENT EA**

code	model	length, m	pcs	folded, cm	weight, g	material
2510000	ELEMENT EA bolo	3.0	3	119	155	composite
2510001	ELEMENT EA bolo	4.0	4	122	220	composite
2510002	ELEMENT EA bolo	5.0	5	122	335	composite
2510003	ELEMENT EA bolo	6.0	6	122	480	composite
2510005	ELEMENT EA pole	3.0	3	113	120	composite
2510006	ELEMENT EA pole	4.0	4	115	180	composite
2510007	ELEMENT EA pole	5.0	5	115	290	composite
2510008	ELEMENT EA pole	6.0	6	115	405	composite



WINTER ROD **FROST DAGGER**

code	model	length, m	pcs	folded, cm	weight, g	spool size, mm	material
2510100	0325FD	0.25	1	20	20	45	plastic

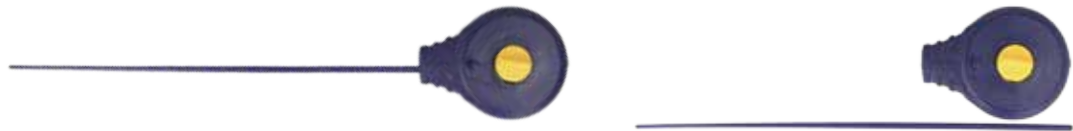

WINTER ROD **POLAR GUIDE**

code	model	length, m	pcs	folded, cm	weight, g	spool size, mm	material
2510105	0245PG	0.45	2	26	43	55	glassplastic
2510106	0248PG	0.48	2	28	53	70	glassplastic
2510107	0452PG	0.52	2	37	41	70	glassplastic



WINTER ROD **POLAR GUIDE TELE**

code	model	length, m	pcs	folded, cm	weight, g	material
2510110	0155PGTL	0.55	3	30	52	composite
2510111	0165PGTL	0.65	3	30	54	composite
2510112	0175PGTL	0.75	3	31	58	composite



**SPECTR FD/RD 1BB**

code	model	gear ratio	weight, g	max. drag power, kg	ball bearings	line capacity, mm-m
1010040	301FD	5.1:1	242	5	1	0.25-245 0.30-170 0.35-125
1010045	401FD	5.1:1	249	5	1	0.30-195 0.35-145 0.40-110
1010050	501FD	5.1:1	318	6	1	0.35-275 0.40-210 0.50-135
1010055	601FD	5.1:1	327	6	1	0.45-195 0.50-155 0.60-110
1010060	301RD	5.1:1	251	5	1	0.25-245 0.30-170 0.35-125
1010065	401RD	5.1:1	257	5	1	0.30-195 0.35-145 0.40-110
1010070	501RD	5.1:1	334	6	1	0.35-275 0.40-210 0.50-135
1010075	601RD	5.1:1	344	6	1	0.45-195 0.50-155 0.60-110

- FD – Front Drag
- RD – Rear Drag
- plastic spool

**SPECTR FD/RD 2BB**

code	model	gear ratio	weight, g	max. drag power, kg	ball bearings	line capacity, mm-m
1010041	302FD	5.1:1	242	5	2	0.25-245 0.30-170 0.35-125
1010046	402FD	5.1:1	249	5	2	0.30-195 0.35-145 0.40-110
1010051	502FD	5.1:1	318	6	2	0.35-275 0.40-210 0.50-135
1010056	602FD	5.1:1	327	6	2	0.45-195 0.50-155 0.60-110
1010061	302RD	5.1:1	251	5	2	0.25-245 0.30-170 0.35-125
1010066	402RD	5.1:1	257	5	2	0.30-195 0.35-145 0.40-110
1010071	502RD	5.1:1	334	6	2	0.35-275 0.40-210 0.50-135
1010076	602RD	5.1:1	344	6	2	0.45-195 0.50-155 0.60-110

- FD – Front Drag
- RD – Rear Drag
- plastic spool





**SPECTR FD/RD 3BB**



code	model	gear ratio	weight, g	max. drag power, kg	ball bearings	line capacity, mm-m
1010042	303FD	5.1:1	242	5	3	0.25-245 0.30-170 0.35-125
1010047	403FD	5.1:1	249	5	3	0.30-195 0.35-145 0.40-110
1010052	503FD	5.1:1	318	6	3	0.35-275 0.40-210 0.50-135
1010057	603FD	5.1:1	327	6	3	0.45-195 0.50-155 0.60-110
1010062	303RD	5.1:1	251	5	3	0.25-245 0.30-170 0.35-125
1010067	403RD	5.1:1	257	5	3	0.30-195 0.35-145 0.40-110
1010072	503RD	5.1:1	334	6	3	0.35-275 0.40-210 0.50-135
1010077	603RD	5.1:1	344	6	3	0.45-195 0.50-155 0.60-110

- FD – Front Drag
- RD – Rear Drag
- plastic spool

**SPECTR FD/RD 4BB**



code	model	gear ratio	weight, g	max. drag power, kg	ball bearings	line capacity, mm-m
1010043	304FD	5.1:1	242	5	4	0.25-245 0.30-170 0.35-125
1010048	404FD	5.1:1	249	5	4	0.30-195 0.35-145 0.40-110
1010053	504FD	5.1:1	318	6	4	0.35-275 0.40-210 0.50-135
1010058	604FD	5.1:1	327	6	4	0.45-195 0.50-155 0.60-110
1010063	304RD	5.1:1	251	5	4	0.25-245 0.30-170 0.35-125
1010068	404RD	5.1:1	257	5	4	0.30-195 0.35-145 0.40-110
1010073	504RD	5.1:1	334	6	4	0.35-275 0.40-210 0.50-135
1010078	604RD	5.1:1	344	6	4	0.45-195 0.50-155 0.60-110

- FD – Front Drag
- RD – Rear Drag
- plastic spool



**FACTOR FD**

code	model	gear ratio	weight, g	max. drag power, kg	ball bearings	line capacity, mm-m
1010080	101FD	5.1:1	224	4	1	0.18-215 0.20-125 0.25-110
1010082	201FD	5.1:1	230	4	1	0.18-240 0.20-195 0.25-125
1010084	301FD	5.1:1	260	5	1	0.25-245 0.30-170 0.35-125
1010086	401FD	5.1:1	284	5	1	0.30-195 0.35-145 0.40-110
1010088	501FD	5.1:1	364	7	1	0.35-275 0.40-210 0.50-135
1010090	601FD	5.1:1	384	7	1	0.45-195 0.50-155 0.60-110
1010081	103FD	5.1:1	224	4	3	0.18-215 0.20-125 0.25-110
1010083	203FD	5.1:1	230	4	3	0.18-240 0.20-195 0.25-125
1010085	303FD	5.1:1	260	5	3	0.25-245 0.30-170 0.35-125
1010087	403FD	5.1:1	284	5	3	0.30-195 0.35-145 0.40-110
1010089	503FD	5.1:1	364	7	3	0.35-275 0.40-210 0.50-135
1010091	603FD	5.1:1	384	7	3	0.45-195 0.50-155 0.60-110

- FD – Front Drag
- plastic spool

**MIST**

code	model	gear ratio	weight, g	max. drag power, kg	ball bearings	line capacity, mm-m
1010403	104FD	5.2:1	194	2.0	4+1	0.20-120

- FD – Front Drag
- metal spool





## MAROON



code	model	gear ratio	weight, g	max. drag power, kg	ball bearings	line capacity, mm-m
1010500	1000	5.2:1	225	4.2	4+1	0.18-235 0.20-195 0.25-120
1010501	2000	5.2:1	240	4.2	4+1	0.18-285 0.20-230 0.25-150
1010502	3000	5.2:1	265	5.0	4+1	0.25-215 0.30-150 0.35-110
1010503	4000	5.2:1	285	5.0	4+1	0.30-175 0.35-130 0.40-110

- metal spool

## spool MAROON



code	model	line capacity, mm-m
1710800	1000	0.18-235 / 0.20-195 / 0.25-120
1710801	2000	0.18-285 / 0.20-230 / 0.25-150
1710802	3000	0.25-215 / 0.30-150 / 0.35-110
1710803	4000	0.30-175 / 0.35-130 / 0.40-110

## REVERS CARP BR



code	model	gear ratio	weight, g	max. drag power, kg	ball bearings	line capacity, mm-m
1010200	4000BR	5.5:1	365	12	3	0.40-140 0.35-180 0.30-250
1010201	5000BR	5.5:1	390	12	3	0.40-180 0.35-230 0.30-320

- Baitrunner system
- plastic spool



## REVERS CARP LONG CAST

**NEW**



code	model	gear ratio	weight, g	max. drag power, kg	ball bearings	line capacity, mm-m
1010204	5000LC	5.2:1	360	12	3	0.20-265 0.25-170 0.30-120
1010205	6000LC	5.2:1	354	12	3	0.30-220 0.35-160 0.40-120

- Baitrunner system
- plastic spool

## spool REVERS CARP BR



code	model	line capacity, mm-m
1710805	5000LC	0.20-265 / 0.25-170 / 0.30-120
1710806	6000LC	0.30-220 / 0.35-160 / 0.40-120

**BLINK**

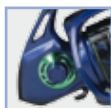

code	model	gear ratio	weight, g	max. drag power, kg	ball bearings	line capacity, mm-m
1010250	2000	5.2:1	235	5	4+1	0.235-100/ #0.8-150
1010251	3000	5.2:1	238	5	4+1	0.250-100/ #1.0-150
1010252	4000	5.2:1	255	6	4+1	0.285-100/ #1.2-150

- metal spool

**NETRINO**

code	model	gear ratio	weight, g	max. drag power, kg	ball bearings	line capacity, mm-m
1010303	5000	5.2:1	300	5.5	3+1	0.24-150 0.30-90 0.35-75
1010304	6000	5.0:1	440	6.5	3+1	0.24-290 0.30-190 0.35-130

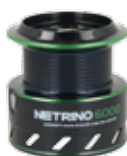
- metal spool

**NEW**
**spool NETRINO**

code	model	line capacity, mm-m
1710810	5000	0.24-150 / 0.30-90 / 0.35-75
1710811	6000	0.24-290 / 0.30-190 / 0.35-130

**NEW**
**POLAR GUIDE**

code	model	diameter of spool, mm	weight, g	ball bearings	line capacity, mm-m
1010030	PG50	50	65	1	0.25-100
1010031	PG60	60	70	1	0.25-180



**601A**

code	model	diameter of spool, mm	weight, g	line capacity, mm-m
1010000	601A	54	45	0.25-100



**701**

code	model	diameter of spool, mm	weight, g	line capacity, mm-m
1010001	701	65	58	0.25-180



**801**

code	model	diameter of spool, mm	weight, g	line capacity, mm-m
1010002	801	64	65	0.25-180



**802**

code	model	diameter of spool, mm	weight, g	line capacity, mm-m
1010003	802	55	36	0.25-240



**806S**

code	model	diameter of spool, mm	weight, g	line capacity, mm-m
1010004	806S	55	29	0.25-100



**808S**

code	model	diameter of spool, mm	weight, g	line capacity, mm-m
1010005	808S	65	45	0.25-180



**ELEMENT PE X4 FLUO GREEN / ORANGE**

FG 100 m	FG 150 m	OR 100 m	OR 150 m	PE #	test, kg	test, lb
4110000	4110010	4110050	4110060	0.6	6.2	13.7
4110001	4110011	4110051	4110061	0.8	7.6	16.8
4110002	4110012	4110052	4110062	1.0	10.3	22.7
4110003	4110013	4110053	4110063	1.2	12.1	26.9
4110004	4110014	4110054	4110064	1.5	13.3	29.3
4110005	4110015	4110055	4110065	2.0	15.7	34.6
4110006	4110016	4110056	4110066	2.5	17.2	37.9
4110007	4110017	4110057	4110067	3.0	19.6	43.2
4110008	4110018	4110058	4110068	3.5	23.0	50.7

- color FG – Fluor Green
- color OR – Orange

**ELEMENT PE X4 MOSS GREEN**

100 m	150 m	1000 m	PE #	test, kg	test, lb
4110030	4110040	4110020	0.6	6.2	13.7
4110031	4110041	4110021	0.8	7.6	16.8
4110032	4110042	4110022	1.0	10.3	22.7
4110033	4110043	4110023	1.2	12.1	26.9
4110034	4110044	4110024	1.5	13.3	29.3
4110035	4110045	4110025	2.0	15.7	34.6
4110036	4110046	4110026	2.5	17.2	37.9
4110037	4110047	4110027	3.0	19.6	43.2
4110038	4110048	4110028	3.5	23.0	50.7

- color – Moss Green

**ELEMENT LEADER BRAID CAMO/SILT**

Camo	Silt	length, m	diameter, mm	test, kg	test, lb
4110100	4110120	25	0.12	7.6	16.8
4110101	4110121	25	0.14	10.3	22.7
4110102	4110122	25	0.16	12.1	26.9
4110103	4110123	25	0.18	13.3	29.3
4110104	4110124	25	0.20	15.7	34.6
4110105	4110125	25	0.22	17.2	37.9
4110106	4110126	25	0.25	19.6	43.2
4110107	4110127	25	0.28	23.0	50.7
4110108	4110128	25	0.30	25.9	57.1
4110109	4110129	25	0.35	31.6	69.7
4110110	4110130	25	0.40	38.7	85.3



**3D ELEMENT CARP MOTOR OIL**



150 m	300 m	diameter, mm	test, kg	test, lb
4010260	4010265	0.256	7.4	16.3
4010261	4010266	0.285	9.5	21.0
4010262	4010267	0.309	10.3	22.7
4010263	4010268	0.330	12.1	26.7
4010264	4010269	0.350	13.4	29.6

- color – Motor Oil

**HI-VIZ ELEMENT CARP ACID GREEN**



150 m	300 m	diameter, mm	test, kg	test, lb
4010250	4010255	0.256	7.4	16.3
4010251	4010256	0.285	9.5	21.0
4010252	4010257	0.309	10.3	22.7
4010253	4010258	0.330	12.1	26.7
4010254	4010259	0.350	13.4	29.6

- color – Acid Green

**3D ELEMENT FEEDER AMBER BROWN**



150 m	300 m	diameter, mm	test, kg	test, lb
4010270	-	0.205	6.0	13.2
4010271	-	0.235	6.7	14.5
4010272	4010280	0.256	7.4	16.3
4010273	4010281	0.285	9.5	21.0
4010274	4010282	0.309	10.3	22.7
4010275	4010283	0.330	12.1	26.7
4010276	4010284	0.350	13.4	29.6

- color – Amber Brown

**HI-VIZ ELEMENT SEA FLUO PINK**



150 m	300 m	diameter, mm	test, kg	test, lb
4010240	4010245	0.256	7.4	16.3
4010241	4010246	0.285	9.5	21.0
4010242	4010247	0.309	10.3	22.7
4010243	4010248	0.330	12.1	26.7
4010244	4010249	0.350	13.4	29.6

- color – Fluo Pink

**ELEMENT CARP FLUO GREEN**

150 m	300 m	1000 m	diameter, mm	test, kg	test, lb
4010120	4010130	-	0.256	7.4	16.3
4010121	4010131	4010140	0.285	9.5	21.0
4010122	4010132	4010141	0.309	10.3	22.7
4010123	4010133	4010142	0.350	13.4	29.6
4010124	4010134	4010143	0.405	16.3	36.0

- color – Fluo Green

**ELEMENT CARP MOSS GREEN**

150 m	300 m	1000 m	diameter, mm	test, kg	test, lb
4010090	4010100	-	0.256	7.4	16.3
4010091	4010101	4010110	0.285	9.5	21.0
4010092	4010102	4010111	0.309	10.3	22.7
4010093	4010103	4010112	0.350	13.4	29.6
4010094	4010104	4010113	0.405	16.3	36.0

- color – Moss Green

**ELEMENT CARP MULTICOLOR**

150 m	300 m	1000 m	diameter, mm	test, kg	test, lb
4010060	4010070	-	0.256	7.4	16.3
4010061	4010071	4010080	0.285	9.5	21.0
4010062	4010072	4010081	0.309	10.3	22.7
4010063	4010073	4010082	0.350	13.4	29.6
4010064	4010074	4010083	0.405	16.3	36.0

- color – Multicolor

**ELEMENT FEEDER BLACK**

150 m	diameter, mm	test, kg	test, lb
4010180	0.205	6.0	13.3
4010181	0.235	6.7	14.5
4010182	0.256	7.4	16.3
4010183	0.285	9.5	21.0
4010184	0.309	10.3	22.7
4010185	0.330	12.1	26.7
4010186	0.350	13.4	29.6

- color – Black



**ELEMENT LONG DISTANCE ORANGE**



150 m	300 m	diameter, mm	test, kg	test, lb
4010150	4010160	0.256	7.4	16.3
4010151	4010161	0.285	9.5	21.0
4010152	4010162	0.309	10.3	22.7
4010153	4010163	0.330	12.1	26.7
4010154	4010164	0.350	13.4	29.6
4010155	4010165	0.405	16.3	36.0

- color – Orange

**ELEMENT SEA YELLOW**



150 m	300 m	diameter, mm	test, kg	test, lb
4010220	4010230	0.256	7.4	16.3
4010221	4010231	0.285	9.5	21.0
4010222	4010232	0.309	10.3	22.7
4010223	4010233	0.330	12.1	26.7
4010224	4010234	0.350	13.4	29.6
4010225	4010235	0.405	16.3	36.0

- color – Yellow

**ELEMENT UNIVERSAL CLEAR**



100 m	150m	1000 m	diameter, mm	test, kg	test, lb
4010020	-	-	0.128	2.4	5.3
4010021	-	-	0.148	2.9	6.4
4010022	4010040	-	0.165	3.2	7.1
4010023	4010041	-	0.185	5.3	11.7
4010024	4010042	-	0.205	6.0	13.2
4010025	4010043	4010050	0.256	7.4	16.3
4010026	4010044	4010051	0.309	10.3	22.7
4010027	4010045	4010052	0.350	13.4	29.6
4010028	4010046	4010053	0.405	16.3	36.0
4010029	4010047	-	0.505	22.6	49.8
4010030	-	-	0.605	25.7	56.7

- color – Clear

**ELEMENT UNIVERSAL BLACK GREEN**

100 m	150 m	diameter, mm	test, kg	test, lb
4010000	4010010	0.185	5.3	11.7
4010001	4010011	0.205	6.0	13.2
4010002	4010012	0.256	7.4	16.3
4010003	4010013	0.309	10.3	22.7
4010004	4010014	0.350	13.4	29.6
4010005	4010015	0.405	16.3	36.0
4010006	4010016	0.505	22.6	49.8
4010007	4010017	0.605	25.7	56.7
4010008	4010018	0.700	28.2	62.2

- color – Black Green

**ELEMENT LEADER CLEAR**

25 m	50 m	diameter, mm	test, kg	test, lb
-	4010200	0.104	1.9	4.2
4010190	4010201	0.128	2.4	5.3
4010191	4010202	0.148	2.9	6.4
4010192	4010203	0.165	3.2	7.1
4010193	4010204	0.185	5.3	11.7
4010194	4010205	0.205	6.0	13.2
4010195	4010206	0.235	6.7	14.3

- color – Clear

**ELEMENT ICE CLEAR WINTER**

30 m	diameter, mm	test, kg	test, lb
4010210	0.104	1.9	4.2
4010211	0.128	2.4	5.3
4010212	0.148	2.9	6.4
4010213	0.165	3.2	7.1
4010214	0.185	5.3	11.7
4010215	0.205	6.0	13.2
4010216	0.235	6.7	14.3

- color – Clear



**KASTMASTER**

**NEW**



size					
length, mm	38	48.5	50.5	53.5	57
weight, g	7	10	14	18	21
SILVER	5410000	5410010	5410020	5410030	5410040
GOLD	5410001	5410011	5410021	5410031	5410041
SILVER/BLUE	5410002	5410012	5410022	5410032	5410042
SILVER/GOLD	5410003	5410013	5410023	5410033	5410043
TIGER	5410004	5410014	5410024	5410034	5410044
FIRE TIGER	5410005	5410015	5410025	5410035	5410045



SILVER



GOLD

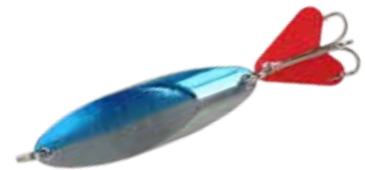

SILVER/BLUE



SILVER/GOLD



TIGER

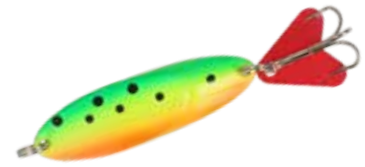

FIRE TIGER



**TRIGGER CRAW**

size	2.7"	3.2"	3.7"
length, mm	68	82	94
weight, g	2.9	4.0	6.4
pcs/pack	8	6	5
002 ULTRA-VIOLET	5610300	5610320	5610340
003 MOTOR OIL RF	5610301	5610321	5610341
004 VIOLET SF	5610302	5610322	5610342
006 CHARTREUSE RF	5610303	5610323	5610343
204 GREEN/RED PP	5610304	5610324	5610344
207 WHITE NIGHT BF	5610305	5610325	5610345
208 FIRE TRUCK PP	5610306	5610326	5610346
209 FIRE/ICE	5610307	5610327	5610347
210 CHART/CRYSTAL BSF	5610308	5610328	5610348
211 BLUE/CRYSTAL SF	5610309	5610329	5610349
212 WATERMELON/YELLOW MF	5610310	5610330	5610350
213 VIOLET/RED BSF	5610311	5610331	5610351



002 ULTRA-VIOLET



003 MOTOR OIL RF



004 VIOLET SF



006 CHARTREUSE RF



204 GREEN/RED PP



207 WHITE NIGHT BF



208 FIRE TRUCK PP



209 FIRE/ICE



210 CHART/CRYSTAL BSF



211 BLUE/CRYSTAL SF



212 WATERMELON/YELLOW MF



213 VIOLET/RED BSF

**PIXIE TAIL**

size	1.7"
length, mm	44
weight, g	0.3
pcs/pack	10
101 GLOW	5610360
102 GLOW MILK SF	5610361
103 GLOW PINK SF	5610362
104 GLOW ORANGE SF	5610363
105 GLOW CHART SF	5610364
106 GLOW ACID GREEN	5610365



101 GLOW



102 GLOW MILK SF



103 GLOW PINK SF



104 GLOW ORANGE SF



105 GLOW CHART SF



106 GLOW ACID GREEN



### CATCHY SHAD

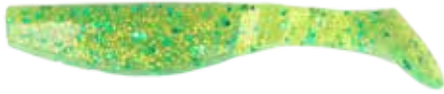

size	2.9"	3.2"
length, mm	75	85
weight, g	5.0	7.2
pcs/pack	8	6



001 BROWN RF	5610380	5610400
002 ULTRA-VIOLET	5610381	5610401
003 MOTOR OIL RF	5610382	5610402
004 VIOLET SF	5610383	5610403
005 ACID GREEN PP	5610384	5610404
006 CHARTREUSE RF	5610385	5610405
201 KIWI	5610386	5610406
202 PUMPKIN	5610387	5610407
203 ULTRA-VIOLET/ACID GREEN	5610388	5610408
204 GREEN/RED PP	5610389	5610409
205 ICE/ACID GREEN	5610390	5610410
206 DRAGON FRUIT	5610391	5610411
207 WHITE NIGHT BF	5610392	5610412
209 FIRE/ICE	5610393	5610413
210 CHART/CRYSTAL BSF	5610394	5610414
211 BLUE/CRYSTAL SF	5610395	5610415
212 WATERMELON/YELLOW MF	5610396	5610416
213 VIOLET/RED BSF	5610397	5610417

### SHEMI SHAD



size	2.7"	3.7"	4.2"
length, mm	70	95	108
weight, g	2.3	5.0	7.5
pcs/pack	8	6	5



001 BROWN RF	5610000	5610030	5610050
002 ULTRA-VIOLET	5610001	5610031	5610051
003 MOTOR OIL RF	5610002	5610032	5610052
004 VIOLET SF	5610003	5610033	5610053
005 ACID GREEN PP	5610004	5610034	5610054
006 CHARTREUSE RF	5610005	5610035	5610055
201 KIWI	5610006	5610036	5610056
202 PUMPKIN	5610007	5610037	5610057
203 ULTRA-VIOLET/ACID GREEN	5610008	5610038	5610058
204 GREEN/RED PP	5610009	5610039	5610059
205 ICE/ACID GREEN	5610010	5610040	5610060
206 DRAGON FRUIT	5610011	5610041	5610061
207 WHITE NIGHT BF	5610012	5610042	5610062
209 FIRE/ICE	5610013	5610043	5610063
210 CHART/CRYSTAL BSF	5610014	5610044	5610064
211 BLUE/CRYSTAL SF	5610015	5610045	5610065
212 WATERMELON/YELLOW MF	5610016	5610046	5610066
213 VIOLET/RED BSF	5610017	5610047	5610067

## TRIGGER SHAD TAIL



size	2.2"	2.9"	3.4"
length, mm	55	75	92
weight, g	0.85	2.0	3.2
pcs/pack	10	8	6
001 BROWN RF	5610080	5610110	5610140
002 ULTRA-VIOLET	5610081	5610111	5610141
003 MOTOR OIL RF	5610082	5610112	5610142
004 VIOLET SF	5610083	5610113	5610143
005 ACID GREEN PP	5610084	5610114	5610144
006 CHARTREUSE RF	5610085	5610115	5610145
201 KIWI	5610086	5610116	5610146
202 PUMPKIN	5610087	5610117	5610147
203 ULTRA-VIOLET/ACID GREEN	5610088	5610118	5610148
204 GREEN/RED PP	5610089	5610119	5610149
205 ICE/ACID GREEN	5610090	5610120	5610150
206 DRAGON FRUIT	5610091	5610121	5610151
207 WHITE NIGHT BF	5610092	5610122	5610152
209 FIRE/ICE	5610093	5610123	5610153
210 CHART/CRYSTAL BSF	5610094	5610124	5610154
211 BLUE/CRYSTAL SF	5610095	5610125	5610155
212 WATERMELON/YELLOW MF	5610096	5610126	5610156
213 VIOLET/RED BSF	5610097	5610127	5610157



## TRIGGER FAT TAIL



size	1.7"	2.7"
length, mm	45	70
weight, g	1.0	3.2
pcs/pack	10	7
001 BROWN RF	5610170	5610190
002 ULTRA-VIOLET	5610171	5610191
003 MOTOR OIL RF	5610172	5610192
004 VIOLET SF	5610173	5610193
005 ACID GREEN PP	5610174	5610194
006 CHARTREUSE RF	5610175	5610195
201 KIWI	5610176	5610196
202 PUMPKIN	5610177	5610197
203 ULTRA-VIOLET/ACID GREEN	5610178	5610198
204 GREEN/RED PP	5610179	5610199
205 ICE/ACID GREEN	5610180	5610200
206 DRAGON FRUIT	5610181	5610201
207 WHITE NIGHT BF	5610182	5610202
209 FIRE/ICE	5610183	5610203
210 CHART/CRYSTAL BSF	5610184	5610204
211 BLUE/CRYSTAL SF	5610185	5610205
212 WATERMELON/YELLOW MF	5610186	5610206
213 VIOLET/RED BSF	5610187	5610207





COMMA GRUB



size	2.4"	3.4"
length, mm	60	85
weight, g	0.7	2.4
pcs/pack	10	7
001 BROWN RF	5610220	5610270
002 ULTRA-VIOLET	5610221	5610271
003 MOTOR OIL RF	5610222	5610272
004 VIOLET SF	5610223	5610273
005 ACID GAREEN PP	5610224	5610274
006 CHARTREUSE RF	5610225	5610275
201 KIWI	5610226	5610276
202 PUMPKIN	5610227	5610277
203 ULTRA-VIOLET/ACID GREEN	5610228	5610278
204 GREEN/RED PP	5610229	5610279
205 ICE/ACID GREEN	5610230	5610280
206 DRAGON FRUIT	5610231	5610281
207 WHITE NIGHT BF	5610232	5610282
209 FIRE/ICE	5610233	5610283
210 CHART/CRYSTAL BSF	5610234	5610284
211 BLUE/CRYSTAL SF	5610235	5610285
212 WATERMELON/YELLOW MF	5610236	5610286
213 VIOLET/RED BSF	5610237	5610287



001 BROWN RF



002 ULTRA-VIOLET



003 MOTOR OIL RF



004 VIOLET SF



005 ACID GREEN PP



006 CHARTREUSE RF



201 KIWI



202 PUMPKIN



203 ULTRA-VIOLET/ACID GREEN



204 GREEN/RED PP



205 ICE/ACID GREEN



206 DRAGON FRUIT



207 WHITE NIGHT BF



209 FIRE/ICE



210 CHART/CRYSTAL BSF



211 BLUE/CRYSTAL SF



212 WATERMELON/YELLOW MF



213 VIOLET/RED BSF

## ISEAMA 101BN



code	N°	pcs/pack
5510005	10	10
5510006	8	10
5510007	6	10
5510008	4	10
5510009	2	10
5510010	1	8
5510011	1/0	8
5510012	2/0	6



- coating - Black Nickel

## ALLROUND 102NI



code	N°	pcs/pack
5510020	14	10
5510021	12	10
5510022	10	10
5510023	8	8
5510024	7	7
5510025	6	7



- coating - Nickel

## FEEDER 103BN



code	N°	pcs/pack
5510030	14	10
5510031	12	10
5510032	10	8
5510033	8	7
5510034	6	7
5510035	4	6



- coating - Black Nickel

## AKITASODE 104BN



code	N°	pcs/pack
5510040	12	10
5510041	10	10
5510042	8	10
5510043	6	10
5510044	4	8



- coating - Black Nickel

## AKITAKITSUNE 105BN



code	N°	pcs/pack
5510050	14	10
5510051	12	10
5510052	10	10
5510053	8	8



- coating - Black Nickel

## SODE 106NI



code	N°	pcs/pack
5510060	12	10
5510061	10	10
5510062	8	10
5510063	6	10
5510064	4	10



- coating - Nickel

## KOAJI 107BN



code	N°	pcs/pack
5510070	14	10
5510071	12	10
5510072	10	10
5510073	8	10
5510074	6	10



- coating - Black Nickel

### CARP DOWN 201BN



code	N°	pcs/pack
5510200	10	10
5510201	8	10
5510202	6	8
5510203	4	8
5510204	2	6
5510205	1	6



- coating - Black Nickel



### CARP CLASSIC 202BN



code	N°	pcs/pack
5510210	10	10
5510211	8	10
5510212	6	10
5510213	4	8
5510214	2	8
5510215	1	6



- coating - Black Nickel



### CATFISH 301BN



code	N°	pcs/pack
5510300	1/0	8
5510301	2/0	7
5510302	4/0	6
5510303	6/0	4



- coating - Black Nickel



### WORM 302BN



code	N°	pcs/pack
5510310	1/0	6
5510311	2/0	5
5510312	3/0	5
5510313	4/0	5
5510314	5/0	4



- coating - Black Nickel



### RYUSEN 401R

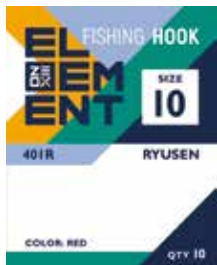

code	N°	pcs/pack
5510400	10	10
5510401	8	10
5510402	6	10
5510403	4	8
5510404	2	6
5510405	1	5
5510406	1/0	5
5510407	2/0	4



- coating - Red



### BAITHOLDER LS 402NI



code	N°	pcs/pack
5510410	8	10
5510411	6	10
5510412	4	10
5510413	2	8
5510414	1	8
5510415	1/0	6
5510416	2/0	6
5510417	3/0	5
5510418	4/0	4



- coating - Nickel
- \* LS - Long Shank



### BAITHOLDER 403NI



code	N°	pcs/pack
5510420	8	10
5510421	6	10
5510422	4	10
5510423	2	10
5510424	1	8
5510425	1/0	8
5510426	2/0	8
5510427	3/0	6
5510428	4/0	6



- coating - Nickel



## BASIC 110BN



code	N°	pcs/pack
5510900	10	100
5510901	9	100
5510902	7	100
5510903	5	100
5510904	3	100
5510905	1	100
5510906	1/0	100
5510907	2/0	100
5510908	3/0	100
5510909	4/0	100
5510910	5/0	100
5510911	6/0	100
5510912	7/0	100
5510913	8/0	100
5510914	9/0	100

- coating – Black Nickel

## BASIC DOUBLE 320BN

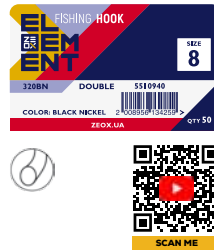

code	N°	pcs/pack
5510940	8	50
5510941	6	50
5510942	4	50
5510943	2	50
5510944	1	50
5510945	1/0	50
5510946	2/0	50

- coating – Black Nickel

## BASIC TREBLE 330BN



code	N°	pcs/pack
5510960	11	30
5510961	10	30
5510962	9	30
5510963	8	30
5510964	7	30
5510965	6	30
5510966	5	30
5510967	4	30
5510968	3	30
5510970	1	30

- coating – Black Nickel

## SALT RIG METAL

code	model	hook, N°	color of hook	hooks, pcs	length, cm
4310000	401R	4	Red	3	130
4310001	401R	2	Red	3	130
4310002	401R	1	Red	3	130
4310005	403NI	4	Nickel	3	130
4310006	403NI	2	Nickel	3	130
4310007	403NI	1	Nickel	3	130

- color of plastic beads – Red, Green (Glow), Yellow, size 6 mm
- diameter of line – 0.50 mm/0.35 mm
- metal wire anti tangle – 15 cm/1.0 mm

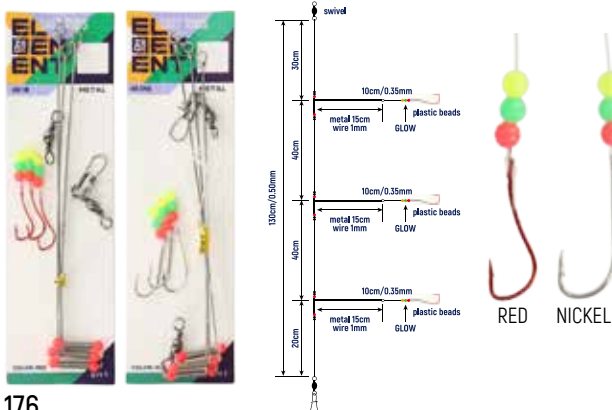

## SALT RIG PLASTIC

code	model	hook, N°	color of hook	hooks, pcs	length, cm
4310020	401R	4	Red	3	130
4310021	401R	2	Red	3	130
4310022	401R	1	Red	3	130
4310025	403NI	4	Nickel	3	130
4310026	403NI	2	Nickel	3	130
4310027	403NI	1	Nickel	3	130

- color of plastic beads – Red, Green (Glow), Yellow, size 6 mm
- diameter of line – 0.50 mm/0.35 mm
- plastic anti tangle – 15 cm/2.0 mm

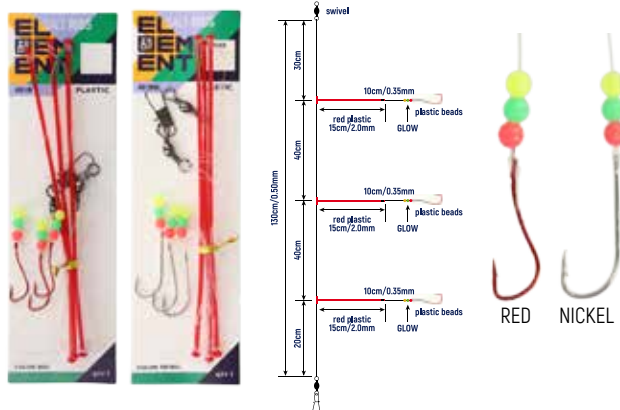





SPLIT SHOT SET **LEAD SPLIT-SHOT**

**NEW**

code	weight, g	set, g	code	weight, g	set, g	code	weight, g	set, g
5210004	80	0.5; 0.6; 0.8; 1.0; 1.2; 1.5; 2.0	5210003	60	0.1; 0.2; 0.25; 0.3; 0.4; 0.5; 0.6	5210002	45	0.8; 1.0; 1.2; 1.5

- material – lead

- material – lead

- material – lead



STOPPER **SILICONE BK 1\*15**

**NEW**

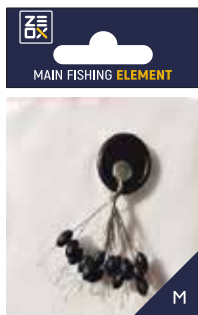

code	size	pcs
1610310	S	1*15
1610311	M	1*15
1610312	L	1*15
1610313	XL	1*15
1610314	XXL	1*15

- color – black

STOPPER **SILICONE YL**



code	size	pcs
1610300	SS	1*6
1610301	S	1*6
1610302	M	1*6
1610303	L	1*6

- 100 pcs/pack
- color – yellow

STOPPER **SILICONE BK**



code	size	pcs
1610305	SS	1*6
1610306	S	1*6
1610307	M	1*6
1610308	L	1*6

- 100 pcs/pack
- color – black

CONNECTOR **ZEOX**



code	diameter, mm
1610200	1.2
1610201	1.4
1610202	1.6
1610203	1.8
1610204	2.0

- 25 pcs/pack
- color – black

## SWIVEL HOOKED SNAP 222BN



code	N°	test, kg	pcs
4510030	10	12	10
4510031	8	14	10
4510032	6	18	8
4510033	4	25	8
4510034	2	30	6

- coating – Black Nickel

## SWIVEL QUICK SNAP 221BN



code	N°	test, kg	pcs
4510020	14	4	10
4510021	12	9	10
4510022	10	12	10
4510023	8	14	10
4510024	6	18	8
4510025	4	25	8
4510026	2	30	6
4510027	1	35	5

- coating – Black Nickel

## QUICK SNAP 201BN



code	N°	test, kg	pcs
4510000	000	4	10
4510001	00	9	10
4510002	0	12	10
4510003	1	18	10
4510004	2	25	10
4510005	3	30	8
4510006	4	35	8

- coating – Black Nickel

## ROLLING SWIVEL 101BN



code	N°	test, kg	pcs
4410002	10	14	10
4410003	8	19	10
4410004	7	22	10
4410005	6	27	10
4410006	5	32	10
4410007	4	35	10
4410008	3	43	8
4410009	2	60	6

- coating – Black Nickel

## BRASS TUBE 301BN



code	N°	test, kg	pcs
1610400	1.0	10	20
1610401	1.2	10	20
1610402	1.4	10	20
1610403	1.6	10	20
1610404	1.8	10	20

- coating – Black Nickel

## CROSS-LINE ROLLING SWIVEL 121BN



code	N°	test, kg	pcs
4410010	6	27	10
4410011	5	32	10
4410012	4	35	10
4410013	3	40	10

- coating – Black Nickel

## SPLIT RING 401NI



code	N°	test, kg	pcs
2110200	4	4	10
2110201	5	8	10
2110202	6	12	10
2110203	7	15	10
2110204	8	20	10

- coating – Nickel

## WIRE LEADER ZEOX



code	length, cm	Ø, mm	test, kg
4210120	10	0.30	15
4210121	15	0.30	15
4210122	17	0.35	20
4210123	20	0.40	26
4210124	25	0.40	26

- 10 pcs/pack
- color – bronze



## FLUOROCARBON LEADER ZEOX



code	length, cm	Ø, mm	test, kg
4210140	15	0.40	10
4210141	15	0.50	12
4210142	15	0.60	14
4210145	20	0.40	10
4210146	20	0.50	12
4210147	20	0.60	14
4210150	25	0.40	10
4210151	25	0.50	12
4210152	25	0.60	14
4210153	25	0.70	18
4210155	30	0.60	14
4210156	30	0.70	18
4210157	35	0.70	18
4210158	40	0.70	18

- 5 pcs/pack
- color – clear



## LEADER ZEOX



code	fibers	length, cm	test, kg
4210100	1×7	15	10
4210101	1×7	15	15
4210102	1×7	20	10
4210103	1×7	20	15
4210104	1×7	25	10
4210105	1×7	25	15
4210110	7×7	20	10
4210111	7×7	20	15
4210112	7×7	25	10
4210113	7×7	25	15

- 2 pcs/pack
- color – bronze



## LEADER SET ZEOX



code	fibers	length, cm	test, kg
4210000	1×7	15	10
		20	
		25	
4210001	1×7	15	15
		20	
		25	
4210002	7×7	20	10
		25	
		30	
4210003	7×7	20	15
		25	
		30	

- 60 pcs/pack
- color – bronze



## ELEMENT BITE ALARM



Simple and reliable electronic bite alarm which has all the necessary settings and functions – volume, sensitivity and tonality adjustments.

Bright LEDs clearly visible at any time of the day.

There is a socket on the body for connecting electronic swinger.

- Light indication of a bite
- Sound indication of a bite
- Tone adjustment
- Volume control
- Sensitivity adjustment



code	6510050	6510051	6510052	6510053
color	blue	green	red	yellow
connection	micro-Jack 2.5 mm	micro-Jack 2.5 mm	micro-Jack 2.5 mm	micro-Jack 2.5 mm
battery (not included)	1 element 6LR61 9V (crone)	1 element 6LR61 9V (crone)	1 element 6LR61 9V (crone)	1 element 6LR61 9V (crone)

## STIFF LUMI

Sensitive swinger for carp fishing with adjustable line tension. The tension can be adjusted by moving the movable weight along the bar.

Equipped with a plug for connecting to bite alarm, due to which the swinger glows during the bite. It also comes with a connector for attachment to rod pod.

Stiff swivel construction almost completely eliminates swinging by wind, and at the same time makes it possible to detect the most careful bites. Ball clip for fishing line completely eliminates its damage. Available in 4 colors.



code	6510000	6510001	6510002	6510003
connection	micro-Jack 2.5 mm	micro-Jack 2.5 mm	micro-Jack 2.5 mm	micro-Jack 2.5 mm
color	blue	green	red	yellow



## ROD HOLDER **ZEON TH**

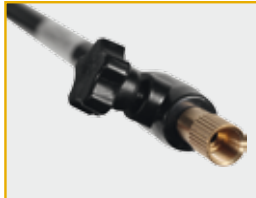

code	6710010	6710011
model	TH-100	TH-120
length, cm	55-100	65-120

- Universal thread
- Material – metal
- Telescopic construction

## ROD HOLDER **ZEON TH-CL**

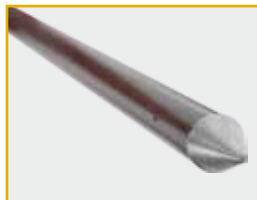

code	6710012	6710013
model	TH-120CL	TH-150CL
length, cm	67-120	80-150

- Universal thread
- Material – aluminum alloy
- Telescopic construction

## ROD HOLDER **FEEDER REST**

The universal feeder rest is made of high-strength plastic that is not afraid of temperature changes and retains its properties in the range from -20 to +50 degrees.

Sufficient width allows you to lay the rod blindly, without risk of damage to the tackle. The clamping screw allows you to adjust the angle of the stand in a wide range – from 0 to 180 degrees.

Universal thread allows you to attach the rest to all types of stands and tripods.



code	6710000	6710001	6710002	6710003	6710004
model	FR-10V	FR-30V	FR-15U	FR-30U	FR-20L

## POLE REST

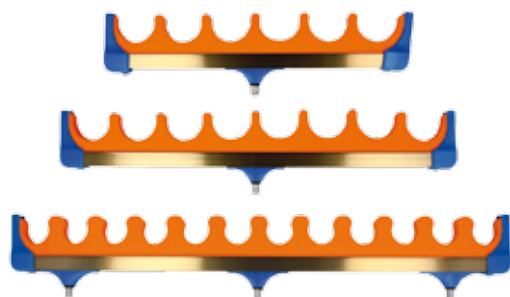

code	section, pcs	length, cm	fastening, pcs
6710100	6	31.5	1
6710101	8	41.5	1
6710102	12	51.5	3

- universal thread
- material – EVA

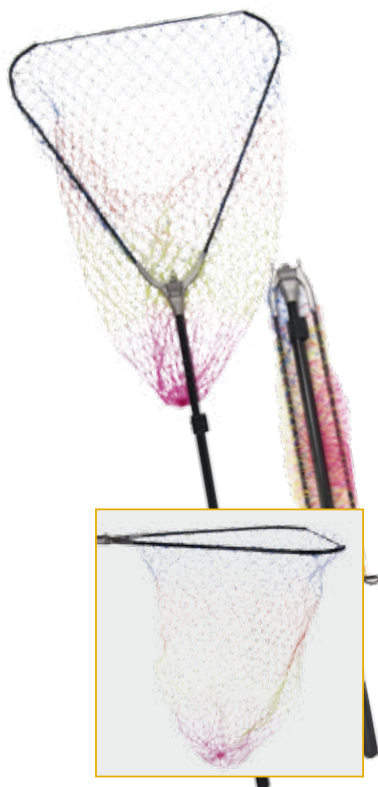
**DELTA UNIVERSAL TELE NM**

code	6610275	6610276
model	NM-60160	NM-70160
maximum length, cm	160	160
pieces	2	2
folded, cm	93	93
material of handle	aluminum	aluminum
sizes of head	60×55	70×60
material of head	aluminum	aluminum
material of mesh	nylon	nylon
sizes of cells, mm	30×30	30×30
depth of net, cm	60	60
color of mesh	multicolor	multicolor
weight, g	540	658

- **folding**

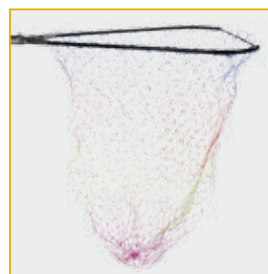
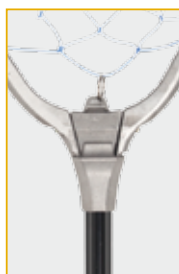
**DELTA UNIVERSAL TELE PEM**

code	6610278	6610279
model	PEM-60160	PEM-70160
maximum length, cm	160	160
pieces	2	2
folded, cm	93	93
material of handle	aluminum	aluminum
sizes of head	60×50	70×60
material of head	aluminum	aluminum
material of mesh	cord thread	cord thread
sizes of cells, mm	30×30	30×30
depth of net, cm	60	60
color of mesh	grey	grey
weight, g	720	740

- **folding**

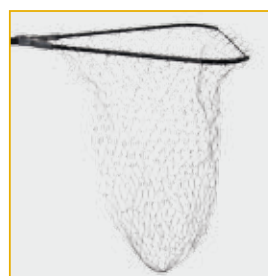

**QUAD FOLDING NM**



code	6610205
model	NM-60180
maximum length, cm	180
pieces	2
folded, cm	106
material of handle	aluminum
sizes of head	60*60
material of head	aluminum
material of mesh	nylon
sizes of cells, mm	30*30
depth of net, cm	60
color of mesh	multicolor
weight, g	880

- folding



**QUAD FOLDING RM**

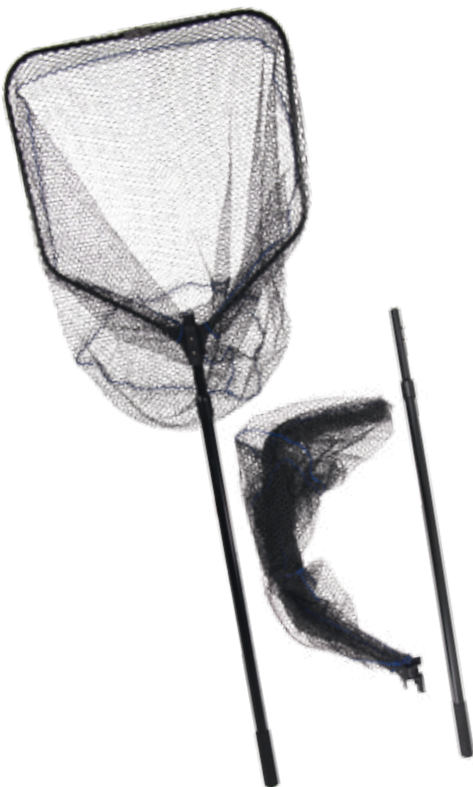

code	6610208
model	RM-60180
maximum length, cm	180
pieces	2
folded, cm	106
material of handle	aluminum
sizes of head	60*60
material of head	aluminum
material of mesh	rubber
sizes of cells, mm	12*12
depth of net, cm	60
color of mesh	black
weight, g	1230

- folding



**DELTA TELE FOLDING RM**

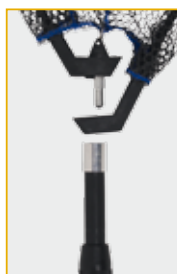

code	6610270	6610271
model	RM-60210	RM-70210
maximum length, cm	210	210
pieces	2	2
folded, cm	115	115
material of handle	composite	composite
sizes of head	60×50	70×60
material of head	composite	composite
material of mesh	rubber	rubber
sizes of cells, mm	7×7	7×7
depth of net, cm	50	60
color of mesh	black	black
weight, g	650	795

- folding

**RING CLASSIC TELE RM**

code	6610152
model	RM-45210
maximum length, cm	210
pieces	2
folded, cm	114
material of handle	composite
sizes of head	50*45
material of head	composite
material of mesh	rubber
sizes of cells, mm	7*7
depth of net, cm	30
color of mesh	black
weight, g	560

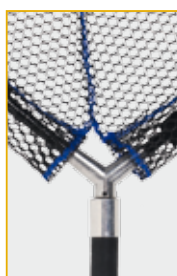
- folding







**DELTA FOLDING RM**



code	6610000	6610001
model	RM-60	RM-70
folded, cm	66	75
sizes of head, cm	60×55	70×65
material of head	composite	composite
material of mesh	rubber	rubber
sizes of cells, mm	8×8	8×8
depth of net, cm	40	60
color of mesh	black	black
weight, g	361	498

- folding

**ELLIPSE PEM-7260155B (CORD THREAD)**

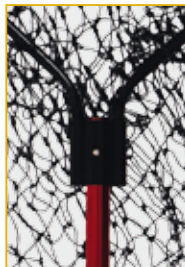
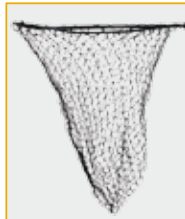
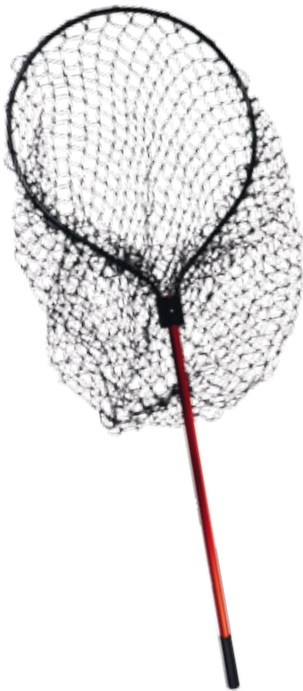

code	6610101
model	PEM-7260155B
maximum length, cm	160
folded, cm	90
material of handle	aluminum
sizes of head, cm	68×58
material of head	aluminum
material of mesh	cord thread
sizes of cells, mm	45×45
depth of net, cm	100
color of mesh	black
weight, g	460

**ELLIPSE FLY**



code	6610102
model	RM-5035070
length, cm	70
folded, cm	70
material of handle	plastic
sizes of head, cm	55×35
material of head	aluminum
material of mesh	rubber
sizes of cells, mm	7×7
depth of net, cm	35
weight, g	350

**SQUARE TELE FOLDING NM**

code	6610200
model	NM-6055220
maximum length, cm	220
pieces	2
folded, cm	88
material of handle	aluminum
sizes of head, cm	60×55
material of head	aluminum
material of mesh	nylon
sizes of cells, mm	30×30
depth of net, cm	90
color of mesh	multicolor

- folding

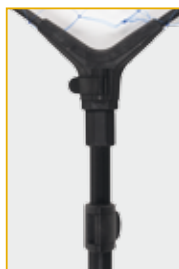
**SQUARE TELE PEM**



code	6610201
model	PEM-6055220
maximum length, cm	220
pieces	2
folded, cm	88
material of handle	aluminum
sizes of head, cm	60×55
material of head	aluminum
material of mesh	cord thread
sizes of cells, mm	30×30
depth of net, cm	90
color of mesh	grey

- folding



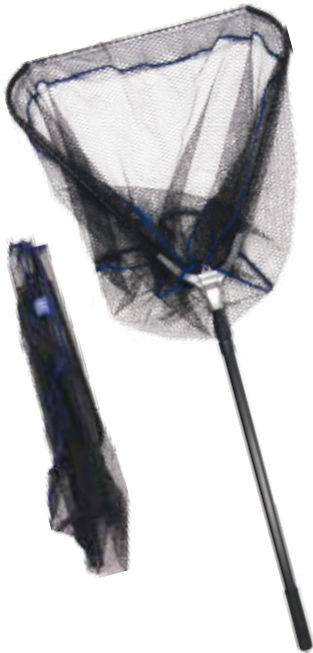

**TRIGON TELE**



code	6610260	6610261	6610262
model	RM-50170N	RM-60180N	RM-70190N
maximum length, cm	170	180	190
pieces	2	2	2
folded, cm	80	80	80
material of handle		aluminum	
sizes of head, cm	50x50	60x60	70x70
material of head		aluminum	
material of mesh		rubber	
sizes of cells, mm	7x7	7x7	7x7
depth of net, cm	40	50	60
color of mesh		black	

- folding

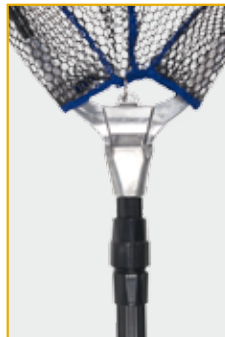

code	6610263	6610264	6610265
model	RM-50170V	RM-60180V	RM-70190V
maximum length, cm	170	180	190
pieces	2	2	2
folded, cm	80	80	80
material of handle		aluminum	
sizes of head, cm	50x50	60x60	70x70
material of head		aluminum	
material of mesh		rubber	
sizes of cells, mm	7x7	7x7	7x7
depth of net, cm	40	50	60
color of mesh		black	

- folding



**ROUND BASIC PLUS**

code	6810005	6810006	6810007
model	PEM-40150	PEM-40200	PEM-40250
number of rings	4	5	6
diameter, cm	40	40	40
length, cm	150	200	250
material of mesh	nylon		
sizes of cells, mm	5×5	5×5	5×5
color	blue		

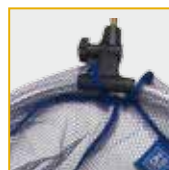
**SQUARE**

code	6810020	6810021	6810022
model	KNS-403020	KNS-403025	KNS-403030
diameter, cm	40×30	40×30	40×30
length, cm	200	250	300
rings material	aluminum		
material of mesh	capron		
sizes of cells, mm	2×2	2×2	2×2
color	black		

**ROUND**

code	6810018	6810019
model	RM-45200	RM-45250
number of rings	5	6
diameter, cm	45	45
length, cm	200	250
rings material	aluminum	
material of mesh	PVC coated	
sizes of cells, mm	8×8	8×8
color	blue	



SCAN ME





## ROUND SHORT

code	6810010	6810011	6810012
model	PEM-3050	PEM-3560	PEM-4575
number of circles	4	4	4
diameter, cm	30	35	45
length, cm	50	60	75
material of mesh	capron		
sizes of cells, mm	3×3	3×3	3×3
color	blue		



## ROUND BASIC

code	6810000	6810001
model	PEM-30090	PEM-35100
number of circles	5	5
diameter, cm	25-30	25-35
length, cm	90	100
material of mesh	capron	
sizes of cells, mm	3×3	3×3
color	blue	



## ROUND METAL

code	6810015	6810016	6810017
model	M	L	XL
diameter, cm	30	35	40
length, cm	35	40	45
mesh	metal		
sizes of cells, mm	15×15	15×15	15×15

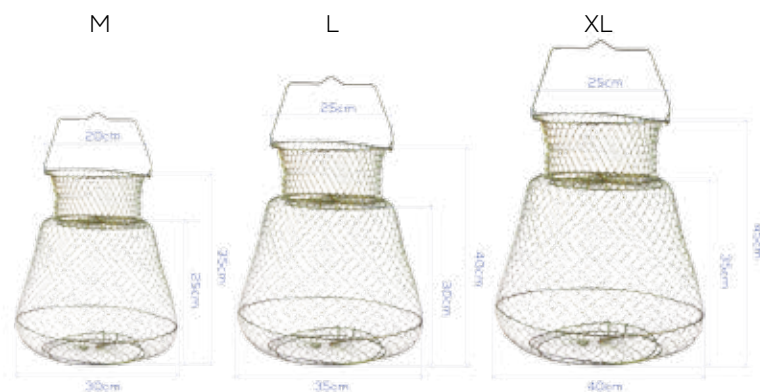

## BAG FOR KEEPNET BASIC EVA

code	7110000	7110001
dimensions, cm	42×42×10	52×52×12
material	EVA 0.8 mm	EVA 0.8 mm



**CLASSIC BACKPACK**

code	7210001
material	PVC600D
dimensions, cm	52×35×17
volume, l	30

**STANDARD BACKPACK**

code	7210002
material	PVC600D
dimensions, cm	52×35×17
volume, l	30

**BACKPACK 43 L**

code	7210000
material	PVC 600D
dimensions, cm	33×20×65
volume, l	43

**HARD CASE REEL-IN**

code	dimensions, cm
7010055	125×10
7010056	135×10
7010057	150×10

- material – PVC 600D (hard)
- section for reel – yes
- number of sections – 1
- color – dark blue



## HARD CASE SLIM



code	dimensions, cm
7010050	118×10
7010051	135×10
7010052	150×10

- material – PVC 600D (hard)
- section for reel – no
- number of sections – 1
- color – dark blue

## STANDARD REEL-IN



code	dimensions, cm
7010020	80×17
7010021	100×17
7010022	135×17
7010023	150×17
7010024	160×17

- material – PVC 840D
- width of section for reel – 23 cm
- number of sections – 2
- color – dark blue

## STANDARD PLUS REEL-IN



code	dimensions, cm
7010030	80×15
7010031	100×15
7010032	135×15
7010033	150×15
7010034	160×15

- material – PVC 840D
- width of section for reel – 23 cm
- number of sections – 2
- color – dark blue

**BASIC REEL-IN**

code	dimensions, cm
7010000	80×17
7010001	100×17
7010002	130×17
7010003	150×17
7010004	160×17

- material – PVC 600D
- width of section for reel – 23 cm
- number of sections – 2
- color – grey



code	dimensions, cm
7010010	80×16
7010011	100×16
7010012	130×16
7010013	150×16
7010014	160×16

- material – PVC 600D
- width of section for reel – 23 cm
- number of sections – 3
- color – grey





ACCESSORIES BOX **ACCESSORY BOX**

**AB-1006 S** **NEW**

code	dimensions, cm
1310010	10×6.5×3



**AB-1210 M** **NEW**

code	dimensions, cm
1310011	12×10.5×3.5



BAIT BOX **LURE BOX** **NEW**

code	1310017	1310015	1310016
model	LB-1910	LB-2212	LB-2216
dimensions, cm	19×10×3.5	22.5×12.5×4.5	22.5×16×6



**BOX REVERSIBLE**

code	1310000	1310001	1310002	1310003
model	RV-80	RV-100	RV-145	RV-165
dimensions, mm	190×85×31	198×127×37	206×170×44	275×187×50
number of sections	14	14	10	14

**BUCKET BAKKAN MINI**

code	dimensions, cm	material	volume, l
1310900	26×24×24	EVA 1 mm	15

- Rope with winder (3 m)

**BUCKET WITH ROPE AND MESH**

code	dimensions, cm	material	volume, l
1310905	20×20×20	EVA 1 mm	8
1310906	25×23×23	EVA 1 mm	15

- Rope with winder (3 m)
- Mesh

**FOLDING ROUND BUCKET**

code	dimensions, cm	material	volume, l
1310910	21×22	PVC	7
1310911	22×23	PVC	9



**ANGLERS FORCEPS**

code	length, cm
1810050	16
1810051	18



**PIKE GAP**

code	length, cm
1810150	18



**STAINLESS FISH STRINGER**

code	rope length, m	qnt. of locks	material
1810200	4.5	5	metal



**LINE KEEPER CLIP-ON**

code	dimensions, mm	Ø blank, mm	material
1610250	150×22×15	14-18	plastic
1610251	150×23×18	16-20	plastic
1610252	155×24×20	18-22	plastic



**REEL GREASE**



code	weight, g
1610900	8

- high viscosity grease, for main gear and slow rotating reel parts

**REEL OIL**



code	weight, g
1610901	10

- liquid grease for ball bearings and fast-rotating parts of the reel

**DUAL ALERT BELLS**



code	pcs/pack
1610000	100

**TIP CLIP TWIN BELL**



code	pcs/pack
1610001	100

**DRYING RACK FOLDING FISH MESH**

code	dimensions, cm	layers, pcs
1810300	35×35×65	3
1810301	45×45×65	3

- sizes of cells 2×2 mm
- material – capron
- color – blue

**ROD STAND**

code	6710020
can fit rods, pcs	16
dimensions, cm	44×90×21
folded, cm	21×47×12

- compact plastic rod stand
- can be used to showcase and store rods
- the double-sided storage stand stacks 8 rods on each side (16 in total)
- color – black/blue
- material – plastic

**TRIPOD TELE**

code	6710200
height min, cm	53
height max, cm	150
folded, cm	56
weight, g:	1060





TIP GUIDE **ZEOX BK PST**

code	inner ring, mm	rod fitting, mm
2110500	5	1.4
2110501	5	1.6
2110502	5	1.8
2110503	5	2.0
2110504	5	2.2
2110505	6	1.6
2110506	6	1.8
2110507	6	2.0
2110508	6	2.2
2110509	6	2.4
2110510	6	2.6
2110515	8	2.0
2110516	8	2.2
2110517	8	2.4
2110518	8	2.6
2110519	8	2.8
2110520	8	3.0

- 20 pcs/pack

code	inner ring, mm	rod fitting, mm
2110525	10	2.4
2110526	10	2.6
2110527	10	2.8
2110528	10	3.0
2110529	10	3.2
2110530	10	3.4
2110535	12	2.8
2110536	12	3.0
2110537	12	3.2
2110538	12	3.4
2110539	12	3.6

- 10 pcs/pack



GUIDES SET **BK YSG 1 STEM**

code	pcs/pack
2110000	60

size, #	4.0	5.0	6.5	8.0	11.5	12.3
pcs/pack	10	10	10	10	10	10

- color - Black



GUIDES SET **BN YSG 1 STEM**

code	pcs/pack
2110001	60

size, #	4.0	5.0	6.5	8.0	11.5	12.3
pcs/pack	10	10	10	10	10	10

- color - Black Nickel



GUIDES SET **BK NSG 2 STEMS**

code	pcs/pack
2110005	65

size, #	4.0	5.0	6.5	8.0
pcs/pack	10	10	10	10

size, #	11.5	14.0	18.0	23.5
pcs/pack	10	5	5	5

- color - Black



**CAP SPORT BLUE**

code	size, cm
2810100	56-59

- cotton – 50%
- polyester – 50%

**CAP TRUCKER BLUE WITH MESH**

code	size, cm
2810101	56-59

- cotton – 50%
- polyester – 50%

**BANDANA ZEOX ELEMENT**

code	size, cm
2810001	50x24

- material – 100% polyester
- sun protection UPF +50

**JERSEY ZEOX ELEMENT CM202**

code	size	width, cm	height, cm	sleeve length, cm
2610110	S	51	102	75
2610111	M	53	106	77
2610112	L	57	112	80
2610113	XL	59	118	84
2610114	XXL	62	124	86
2610115	XXXL	66	130	87

- material – 100% polyester
- sun protection UPF +50

**SUNGLASSES POLARIZED ELEMENT MBL**

code	2910000	2910001	2910002	2910003
lens color	Blue	Brown	Mirror	Red





**G.CARP**

**GET YOUR BEST CATCH**

[goldencatch.fishing](http://goldencatch.fishing)